



10/2016

System pro *E* energy TwinLine S 43

System pro *E*

Content

System pro <i>E</i> energy TwinLine S 43 cabinet system	1
System pro <i>E</i> combi CombiLine S modular distribution panel system	2
Examples of configuration	3
Index	4

TwinLine S 43

The new modular wall-mounting and floor-standing cabinets

1

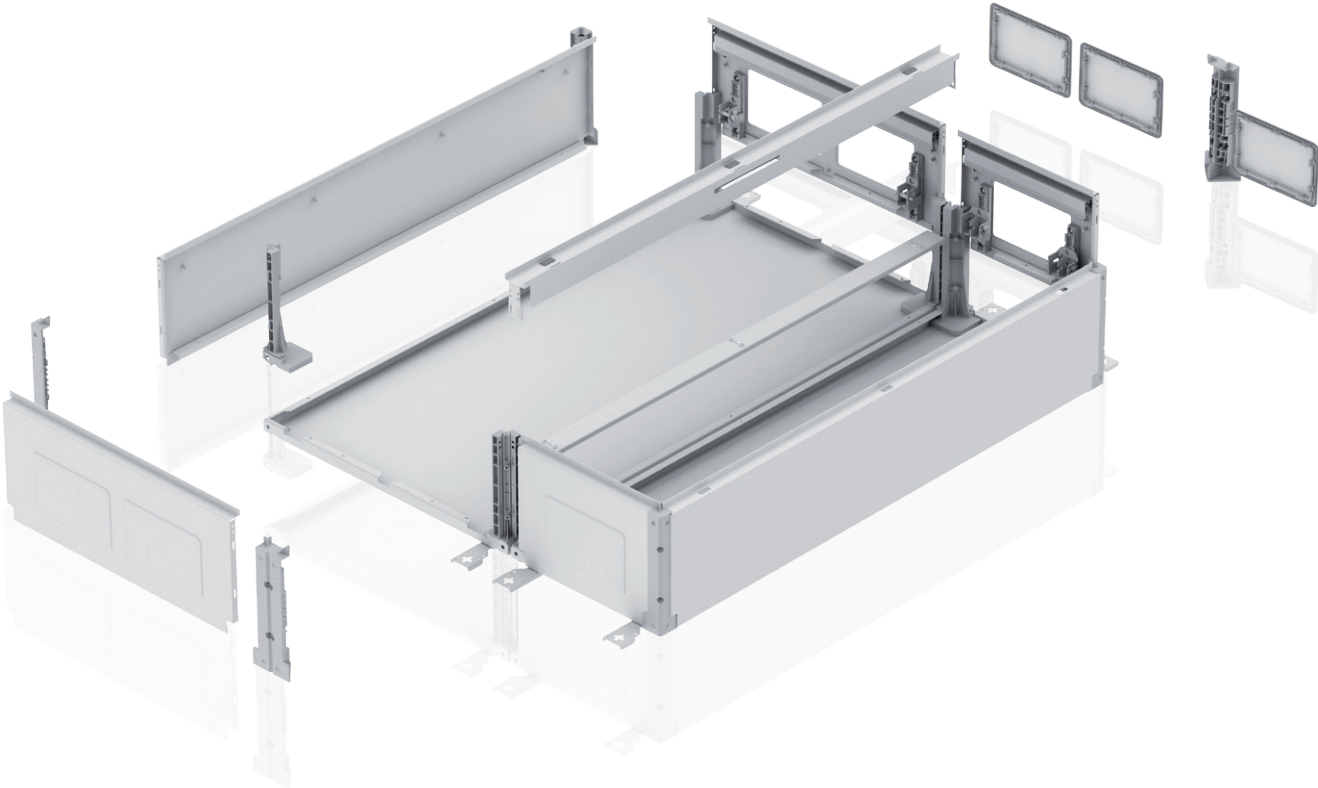

TwinLine S 43

The new modular wall-mounting and floor-standing cabinets

With the new TwinLine S 43 system, ABB offers a tailored and proven concept of modular wall-mounting and floor-standing cabinets.

This fully comprehensive product range includes two cabinet types TwinLine-G (depth of 225 mm) and TwinLine-L (depth of 275 mm) and provides a solution for every application. All cabinets are designed according to IEC 61439. The modular system is simple in planning, quick in assembly and safe in application.

A wide range of flange types provides the right solution for every application. All flanges are suited for all flange openings and knockouts of the complete TwinLine series. The flanges can be attached without the need of tools thanks to the handy push and lock technology.

All TwinLine cabinets can be connected in both, horizontally and vertically directions. Uprights for side-by-side positioning and connection sets for stacking the cabinets can be easily installed. The new plinth concept provides a safe transport in the workshop and on-site. The standard heights of 50 mm and 100 mm can be stacked and combined in order to fulfil installation needs.

TwinLine offers unrestricted access during operation, expansion, maintenance and functional monitoring. With its 180-degree door opening and the door locking system, with the possibility to switch the door hinges from right to left it guarantees excellent flexibility. The removable frame as standard gives the possibility to remove all covers in one handling and provides a quick assembly.

With its wide range of the new modular distribution panel system, called CombiLine S, ABB offers the right solution for every application. The internal configuration system fits in all TwinLine S 43 cabinets. CombiLine S provide a time-saving installation due to hook-in technology and a simple closure system for covers with the ¼ turn quick-lock. With its new mounting concept for the CombiLine S system, TwinLine provides more flexibility and access for installation and wiring. There is also the option to have continuous mounting plates that can be adjusted in depth.

Product benefits

- Innovative flange technology
- Significantly more usable area for cable entry
- All flanges are compatible with all flange openings and knockouts within the entire TwinLine system
- Simple connection of all cabinets in both, horizontally and vertically
- Modular plinth concept
- Optimal accessibility and ease of installation thanks to 180 degree door opening angle
- Wide range of the new modular distribution panel system, called CombiLine S
- Simplified accessories concept for reduced inventory levels
- Speedy and concise planning and calculations with the software

TwinLine S 43

The complete cabinet system in all sizes

1

With the new TwinLine S 43 system, ABB offers a tailored and future-proof concept of modular wall-mounting and floor-standing cabinets. This fully comprehensive product range includes two cabinet types TwinLine-G (depth of 225 mm) and TwinLine-L (depth of 275 mm) and provides a solution for every application.

All cabinets are designed according to IEC 61439. The modular system is simple in planning, quick in assembly and safe in application. Highlights such as the innovative flange technology, optimal accessibility, ease of cabinet connection, the modular plinth concept and a flexible assembly of the new internal configuration, guarantee a modern energy distribution.



TwinLine S 43

The complete cabinet system in all sizes

Simple in planning

Quick in assembly

Safe in application

1

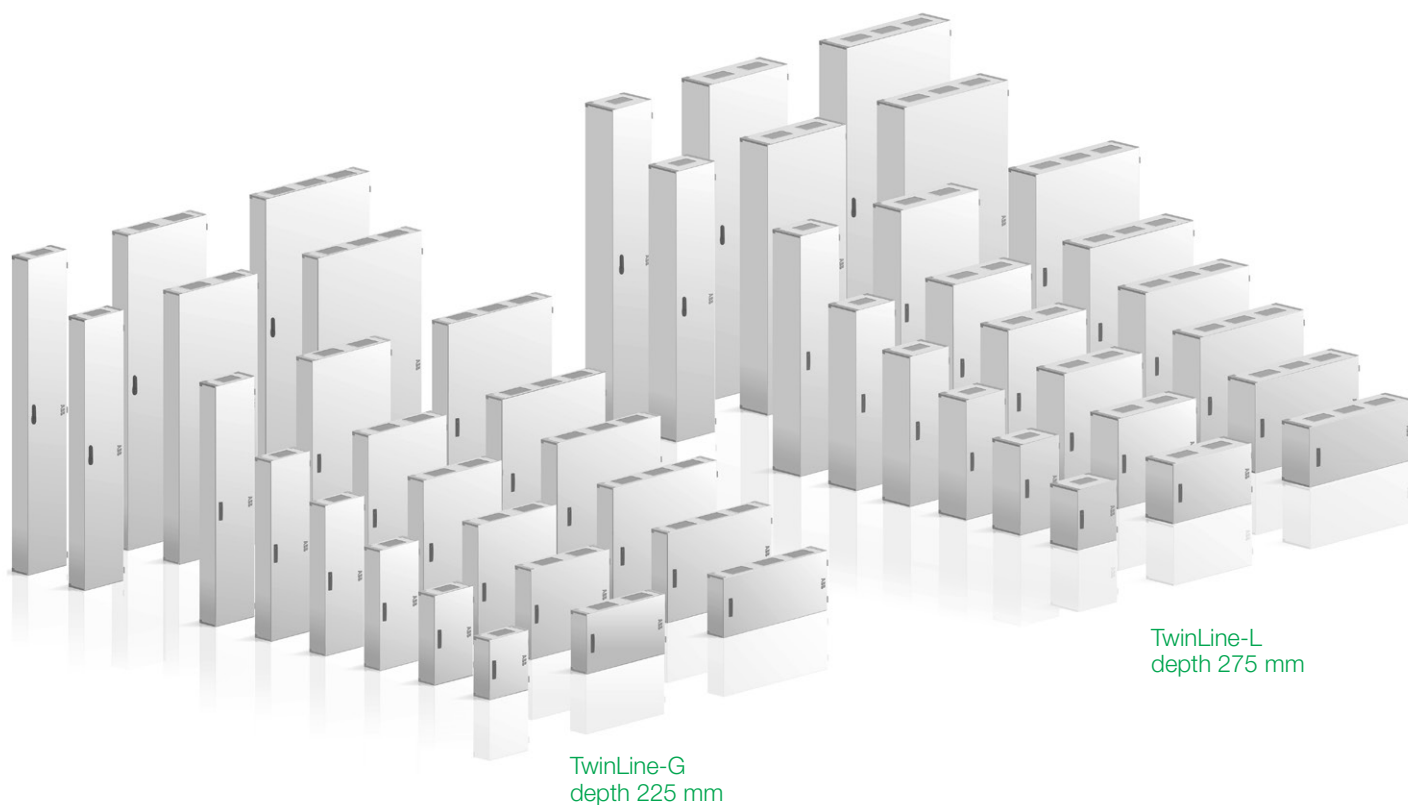

Cabinet type	TwinLine-G			TwinLine-L		
Degree of protection	up to IP43			up to IP43		
Protection class	⚡			⚡		
Depth	225			275		
Width	300	600	800	300	600	800
Height	400	600	800	400	600	800
	1000	1200	1400	1000	1200	1400
	1600	1800	2000	1600	1800	2000

> Dimensions in mm

TwinLine S 43

Product benefits

1

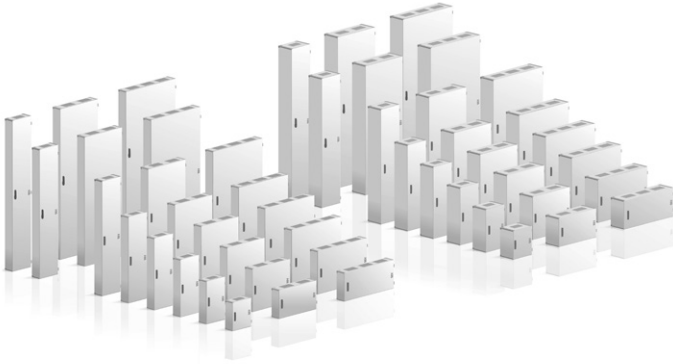

The complete cabinet system in all sizes

The fully comprehensive product range of modular wall-mounting and floor-standing cabinets includes the types TwinLine-G (depth of 225 mm) and TwinLine-L (depth of 275 mm) and provides a solution for every application. All cabinets are designed according to IEC 61439. The modular system is simple in planning, quick in assembly and safe in application.

> The complete cabinet system in all sizes see page 7



Innovative cable entry

A wide range of flange types provides the right solution for every application. All flanges are suited for all flange openings and knockouts of the complete TwinLine cabinets. The flanges can be attached without the need of tools thanks to the handy push and lock technology.

> Innovative cable entry see page 10



Simple connection in series of all cabinets

All TwinLine cabinets can be connected in both, horizontally and vertically directions. Uprights for side-by-side positioning and connection sets for stacking the cabinets can be easily installed.

> Simple connection in series of all cabinets see page 12



Time-saving plinth installation and safe transport

The new plinth concept provides a safe transport in the workshop and on-site. The plinth contains knockouts and has the possibility to install wiring ducts for cable support. The standard heights of 50 mm and 100 mm can be stacked and combined in order to fulfil installation needs.

> Time-saving plinth assembly and safe transport see page 13

TwinLine S 43

Product benefits

1

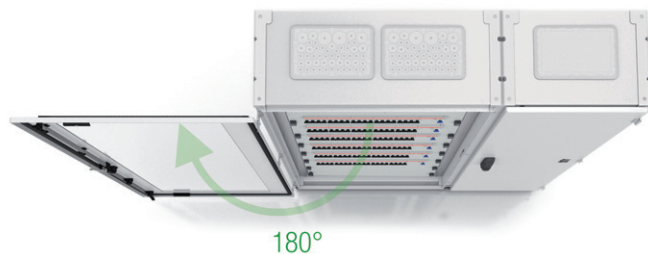

Optimal accessibility and ease of installation

TwinLine offers unrestricted access during operation, expansion, maintenance and functional monitoring. With its 180-degree door opening and the door locking system, with the possibility to switch the door hinges from right to left it guarantees excellent flexibility.

> Optimal accessibility for installation see page 14



Removable frame for CombiLine S covers

With its wide range of the new modular distribution panel system, called CombiLine S, ABB offers the right solution for every application. The removable frame as standard gives the possibility to remove all covers in one handling and provides a quick assembly.

> Internal configuration system see page 14



Flexibility in the assembling of internal configuration

With its new mounting concept for the CombiLine S system, TwinLine provides more flexibility and access for installation and wiring also outside of the cabinet. There is also the option to have continuous mounting plates that can be adjusted in depth.

> Flexibility in the assembling of the internal configuration see page 15



The right internal configuration for every type of application

The wide range of the internal configuration system CombiLine S fits in all TwinLine S 43 cabinets. CombiLine S provides a time-saving installation due to hook-in technology and a simple closure system for covers with the 1/4 turn quick-lock.

> The right module for every type of application see page 48

TwinLine S 43

Innovative cable entry

1

The usable cable entry area is one of largest cable entries available on the market. A wide range of flange types provides the right solution for every application. All flanges are suited for all flange openings and knockouts of the complete TwinLine cabinets. The flanges can be attached without the need of tools thanks to the handy push and lock technology.

- All flanges are compatible with all flange openings and knockouts within the entire TwinLine system
- Wide range of new flanges
- Tool-free flange installation thanks to push and lock technology



Membrane flange

- 2-component flange with integrated seal, material: plastic
- Tool-free installation thanks to push and lock technology
- Optimal cable entry by a combination of hard and soft components
- Additional fixing and centring

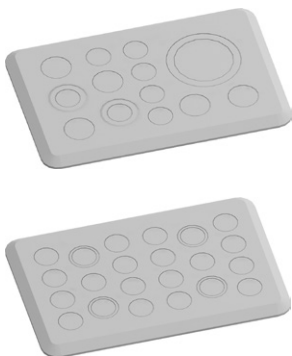

Flange for M screw fittings

- 2-component flange with integrated seal, material: plastic
- Tool-free installation thanks to push and lock technology
- With two different hole patterns

> Flanges see page 24

TwinLine S 43

Innovative cable entry

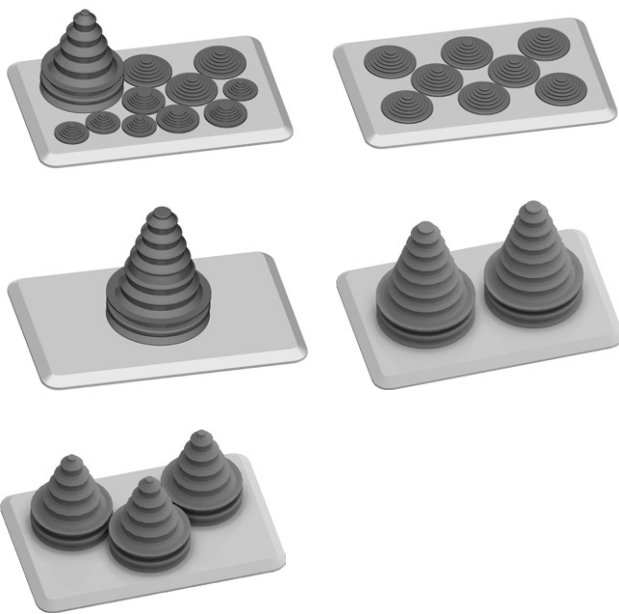

Flange with cable sleeves

- 2-component flange with integrated seal, material: plastic
- Tool-free installation thanks to push and lock technology



Closing flange

- 2-component flange with integrated seal, material: plastic
- Tool-free installation thanks to push and lock technology
- Can be used as closing flange or for customization, e.g. for cable sleeves or screw fittings



Closing flange

- With foam seal around perimeter, material: sheet steel 2 mm
- Continuous protective earth connection via flange fastener
- Can be used as closing flange or for customization, e.g. for cable sleeves or screw fittings

> Flanges see page 24

TwinLine S 43

Simple connection in series of all cabinets

1

All TwinLine cabinets can be connected in both, horizontally and vertically directions. Uprights for side-by-side positioning and connection sets for stacking the cabinets (up to 255 kg) can be easily installed.



TwinLine S 43

Time-saving plinth assembly and safe transport

The new, innovative cabinet plinth literally forms the foundation of the TwinLine floor-standing cabinets while providing the perfect answer to the requests from the field for greater ease of installation. The plinth consists of four parts: the already connected corner and side parts and the front and back trim covers.

Removing the front and back trim covers makes transport more secure. You want to connect a cabinet in series? Not a problem with this cabinet plinth, since cable ducts and M-screw fittings can be fed through knockouts in the side parts.

To ease cross wiring it is also possible to integrate cable ducts. The plinths are available in heights of 50 and 100 mm and can be stacked or combined.

Plinth with 50 and 100 mm height

- Innovative cabinet plinth for easy installation
- Up to three plinths can be “stacked” on top of each other (no additional accessories needed)
- The plinths of 50 and 100 mm height can be combined

Plinth with 100 mm height

- Optimal feed-through of cables using the side knockouts for cable ducts or cable screw fittings
- Quick cable duct installation in the plinth

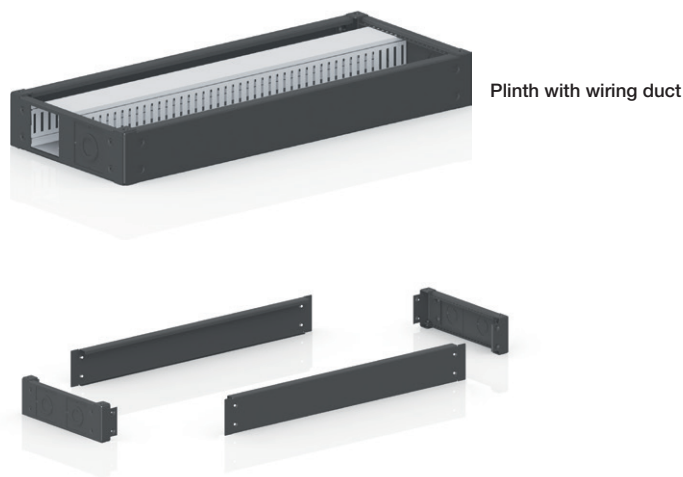

TwinLine S 43

Optimal accessibility for installation

1

The new series of cabinets also offers impressive accessibility with their 180-degree door opening angle. The removable frame for covers enables optimum access during operation, maintenance and function monitoring.

- The door opening angle is 180 degrees for both, individual cabinets and cabinets connected in series
- The innovative locking system is easy to install and allows you to quickly modify the door hinge
- Removable frame as standard makes it possible to remove all covers in one handling
- Significantly reduced installation time

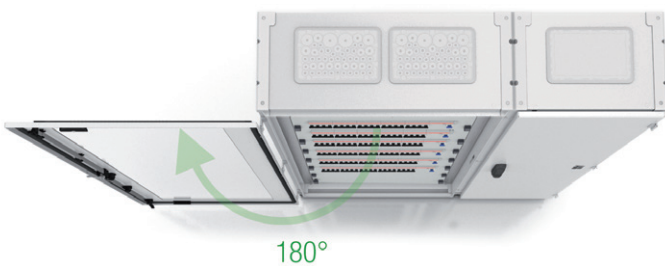

Doors with 180 degree opening angle

TwinLine offers unrestricted access during operation, expansion, maintenance and functional monitoring. With its 180-degree door opening and the door locking system, with the possibility to switch the door hinges from right to left it guarantees excellent flexibility.



Removable frame for CombiLine S covers

With its wide range of the new modular distribution panel system, called CombiLine S, ABB offers the right solution for every application. The removable frame as standard gives the possibility to remove all covers in one handling and provides a quick assembly.

TwinLine S 43

Flexibility in assembly

Flexibility in the assembling of the internal configuration
With its new mounting concept for the CombiLine S system,
TwinLine provides more flexibility and access for
installation and wiring.

1



Depending on the customers requirements there are **two options to install and wire the internal configuration:**

- Outside of the cabinet to have access from all sides
- Placed horizontally on two trestles to do the assembling and wiring inside the cabinet

There is also the option to have continuous mounting plates that can be adjusted in depth.



TwinLine S 43

System overview

1

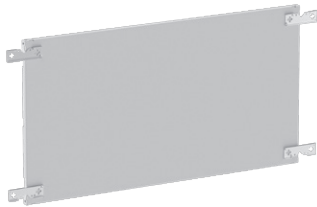
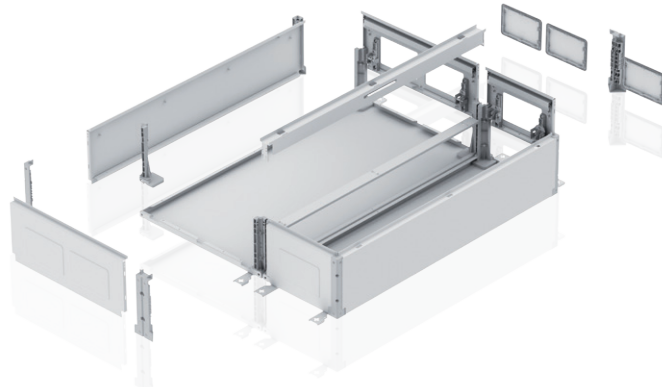

Rear wall



Top and bottom plate

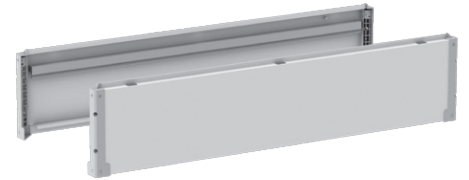

Side walls

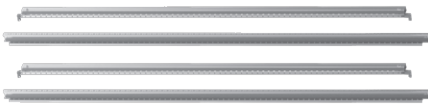

Installation set for removable frame



Uprights for side-by-side positioning of cabinets



Internal cable container

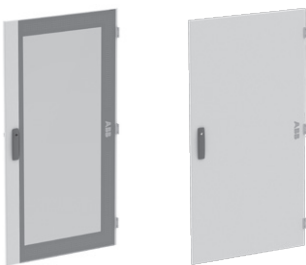

Transparent or sheet steel doors



Flanges



Plinth

- > Rear walls see page 18
- > Top and bottom plate see page 19
- > Side walls see page 20
- > Uprights for side-by-side positioning of cabinets see page 20
- > Installation set / internal cable container / mounting plates see page 21
- > Sheet steel doors see page 22
- > Transparent doors see page 23
- > Flanges see page 24
- > Plinth see page 25

TwinLine S 43

Technical specifications

Technical specifications

Standards / regulations	IEC 61439 -1/-2/-3*
Protection class	I, earthed, in combination with CAEC6
Degree of protection	IP43 Without door IP30
Mechanical impact strength	IK 08 for the cabinet enclosure IK 07 in the area of the flange knockouts IK 07 for transparent doors IK 08 for sheet steel doors
Conditions of installation	Indoor installation Ambient air temperature max. + 40°C Ambient air temperature min. - 5°C Operating temperature max. + 55°C Storage temperature max. + 55°C Storage temperature min. - 40°C

Product features

Housing and door	Sheet steel, RAL 7035, powder-coated Door opening angle: 180 degrees Doors with espagnolette closure Doors for wall-mounting cabinets: with latch plate and 3 mm double bit pin Doors for floor-standing cabinets: with swivel handle and 3 mm double bit pin
Assembly options	Prepared to be fitted with CombiLine S modules and mounting plates
Forms of delivery	Build-up cabinets out of sets

* Powerloss determined by calculation with the method of IEC 60890 in accordance with IEC 61439-1 par. 10.10.4
The required values of the powerloss capacity are specified in tables from page 31.

TwinLine S 43

Rear walls

1



ESBN0612

Article	Height in mm	Type	Ord. no.	Price	Pcs.
Rear walls					
With external mounting brackets					
Width 300 mm					
	400	ESBN0304	2CPX078100R9999		1
	600	ESBN0306	2CPX078101R9999		1
	800	ESBN0308	2CPX078102R9999		1
	1000	ESBN0310	2CPX078103R9999		1
	1200	ESBN0312	2CPX078104R9999		1
	1400	ESBN0314	2CPX078105R9999		1
	1600	ESBN0316	2CPX078106R9999		1
	1800	ESBN0318	2CPX078107R9999		1
	2000	ESBN0320	2CPX078108R9999		1
Width 600 mm					
	400	ESBN0604	2CPX078109R9999		1
	600	ESBN0606	2CPX078110R9999		1
	800	ESBN0608	2CPX078111R9999		1
	1000	ESBN0610	2CPX078112R9999		1
	1200	ESBN0612	2CPX078113R9999		1
	1400	ESBN0614	2CPX078114R9999		1
	1600	ESBN0616	2CPX078115R9999		1
	1800	ESBN0618	2CPX078116R9999		1
	2000	ESBN0620	2CPX078117R9999		1
Width 800 mm					
	400	ESBN0804	2CPX078118R9999		1
	600	ESBN0806	2CPX078119R9999		1
	800	ESBN0808	2CPX078120R9999		1
	1000	ESBN0810	2CPX078121R9999		1
	1200	ESBN0812	2CPX078122R9999		1
	1400	ESBN0814	2CPX078123R9999		1
	1600	ESBN0816	2CPX078124R9999		1
	1800	ESBN0818	2CPX078125R9999		1
	2000	ESBN0820	2CPX078126R9999		1

- > Top and bottom plate see page 19
- > Side walls see page 20
- > Uprights for side-by-side positioning of cabinets see page 20
- > Installation set / internal cable container / mounting plates see page 21
- > Sheet steel doors see page 22
- > Transparent doors see page 23
- > Flanges see page 24
- > Plinth see page 25
- > Lock replacement parts see page 26
- > General accessories see page 28

TwinLine S 43

Top and bottom plate



ESPL0600



ESCL0600

Article	Width in mm	Type	Ord. no.	Price	Pcs.
Top and bottom plates					
Type 1: One plate, all flanges open					
One plate, all flanges closed with knockouts					
Depth 225 mm	300	ESPG0300	2CPX078145R9999		2
	600	ESPG0600	2CPX078146R9999		2
	800	ESPG0800	2CPX078147R9999		2
Depth 275 mm	300	ESPL0300	2CPX078148R9999		2
	600	ESPL0600	2CPX078149R9999		2
	800	ESPL0800	2CPX078150R9999		2
Type 2: Both plates, all flanges closed with knockouts					
Depth 225 mm	600	ESCG0600	2CPX078373R9999		2
	800	ESCG0800	2CPX078374R9999		2
Depth 275 mm	600	ESCL0600	2CPX078375R9999		2
	800	ESCL0800	2CPX078376R9999		2

- > Rear walls see page 18
- > Side walls see page 20
- > Uprights for side-by-side positioning of cabinets see page 20
- > Installation set / internal cable container / mounting plates see page 21
- > Sheet steel doors see page 22
- > Transparent doors see page 23
- > Flanges see page 24
- > Plinth see page 25
- > Lock replacement parts see page 26
- > General accessories see page 28

TwinLine S 43

Side walls / uprights for side-by-side positioning of cabinets

1



ESSL0012

Article	Height in mm	Type	Ord. no.	Price	Pcs.
Side walls*					
Depth 225 mm	400	ESSG0004	2CPX078127R9999		2
	600	ESSG0006	2CPX078128R9999		2
	800	ESSG0008	2CPX078129R9999		2
	1000	ESSG0010	2CPX078130R9999		2
	1200	ESSG0012	2CPX078131R9999		2
	1400	ESSG0014	2CPX078132R9999		2
	1600	ESSG0016	2CPX078133R9999		2
	1800	ESSG0018	2CPX078134R9999		2
	2000	ESSG0020	2CPX078135R9999		2
	Depth 275 mm	400	ESSL0004	2CPX078136R9999	
600		ESSL0006	2CPX078137R9999		2
800		ESSL0008	2CPX078138R9999		2
1000		ESSL0010	2CPX078139R9999		2
1200		ESSL0012	2CPX078140R9999		2
1400		ESSL0014	2CPX078141R9999		2
1600		ESSL0016	2CPX078142R9999		2
1800		ESSL0018	2CPX078143R9999		2
2000		ESSL0020	2CPX078144R9999		2



ESUL0012

Uprights for side-by-side positioning of cabinets					
Depth 225 mm	400	ESUG0004	2CPX078223R9999		1
	600	ESUG0006	2CPX078224R9999		1
	800	ESUG0008	2CPX078225R9999		1
	1000	ESUG0010	2CPX078226R9999		1
	1200	ESUG0012	2CPX078227R9999		1
	1400	ESUG0014	2CPX078228R9999		1
	1600	ESUG0016	2CPX078229R9999		1
	1800	ESUG0018	2CPX078230R9999		1
	2000	ESUG0020	2CPX078231R9999		1
	Depth 275 mm	400	ESUL0004	2CPX078232R9999	
600		ESUL0006	2CPX078233R9999		1
800		ESUL0008	2CPX078234R9999		1
1000		ESUL0010	2CPX078235R9999		1
1200		ESUL0012	2CPX078236R9999		1
1400		ESUL0014	2CPX078237R9999		1
1600		ESUL0016	2CPX078238R9999		1
1800		ESUL0018	2CPX078239R9999		1
2000		ESUL0020	2CPX078240R9999		1

* If ordering a cabinet IP30 without door, you need to order an additional package of TZ628P10 (closing plugs for hinge cutouts)

- > Rear walls see page 18
- > Top and bottom plate see page 19
- > Installation set / internal cable container / mounting plates see page 21
- > Sheet steel doors see page 22
- > Transparent doors see page 23
- > Flanges see page 24
- > Plinth see page 25
- > Lock replacement parts see page 26
- > General accessories see page 28

TwinLine S 43

Installation set / internal cable container / mounting plates



ESIN0012



ESAN0012



ESAI0212



TZM304

Article	Height in mm	Width in mm	Type	Ord. no.	Price	Pcs.
Installation set with removable frame						
For internal configuration in 300 mm, 600 mm, 800 mm wide cabinets.	400		ESIN0004	2CPX078420R9999		1
	600		ESIN0006	2CPX078421R9999		1
Rear profile (from ESIN...) for assembling the CombiLine S distribution panel, for example in the external cable container.	800		ESIN0008	2CPX078422R9999		1
	1000		ESIN0010	2CPX078423R9999		1
	1200		ESIN0012	2CPX078424R9999		1
	1400		ESIN0014	2CPX078425R9999		1
The installation set is needed to assemble the CombiLine S distribution panel. It consists of two rear profiles (ESAN...).	1600		ESIN0016	2CPX078426R9999		1
	1800		ESIN0018	2CPX078427R9999		1
The removable frame consists of two front profiles needed to assemble the covers.	2000		ESIN0020	2CPX078428R9999		1
Installation profile						
Rear profile (from ESIN...) for assembling the CombiLine S distribution panel, for example in the external cable container	400		ESAN0004	2CPX078486R9999		1
	600		ESAN0006	2CPX078487R9999		1
	800		ESAN0008	2CPX078488R9999		1
	1000		ESAN0010	2CPX078489R9999		1
	1200		ESAN0012	2CPX078490R9999		1
	1400		ESAN0014	2CPX078491R9999		1
	1600		ESAN0016	2CPX078492R9999		1
	1800		ESAN0018	2CPX078493R9999		1
	2000		ESAN0020	2CPX078494R9999		1
Internal cable container						
With hinged internal blind cover	600		ESAI0206	2CPX078215R9999		1
For 800 mm wide cabinets	800		ESAI0208	2CPX078216R9999		1
	1000		ESAI0210	2CPX078217R9999		1
	1200		ESAI0212	2CPX078218R9999		1
	1400		ESAI0214	2CPX078219R9999		1
	1600		ESAI0216	2CPX078220R9999		1
	1800		ESAI0218	2CPX078221R9999		1
	2000		ESAI0220	2CPX078222R9999		1
Mounting plates						
Sheet steel	600	600	TZM204	2CPX010598R9999		1
2 mm, galvanised		800	TZM304	2CPX010605R9999		1
	1200	600	TZM208	2CPX010602R9999		1
		800	TZM308	2CPX010609R9999		1
	1800	600	TZM212	2CPX010941R9999		1
		800	TZM312	2CPX010942R9999		1

- > Rear walls see page 18
- > Top and bottom plate see page 19
- > Side walls see page 20
- > Uprights for side-by-side positioning of cabinets see page 20
- > Sheet steel doors see page 22
- > Transparent doors see page 23
- > Flanges see page 24
- > Plinth see page 25
- > Lock replacement parts see page 26
- > General accessories see page 28

TwinLine S 43

Sheet steel doors

1



ESAS0612



ESAS0618

Article	Height in mm	Type	Ord. no.	Price	Pcs.
Doors for wall-mounting cabinets, with latch plate and double bit 3 mm					
Doors for floor-standing cabinets, with swivel handle and double bit 3 mm					
Width 300 mm					
	400	ESAS0304	2CPX078151R9999		1
	600	ESAS0306	2CPX078152R9999		1
	800	ESAS0308	2CPX078153R9999		1
	1000	ESAS0310	2CPX078154R9999		1
	1200	ESAS0312	2CPX078155R9999		1
	1400	ESAS0314	2CPX078156R9999		1
	1600	ESAS0316	2CPX078157R9999		1
	1800	ESAS0318	2CPX078158R9999		1
	2000	ESAS0320	2CPX078159R9999		1
Width 600 mm					
	400	ESAS0604	2CPX078160R9999		1
	600	ESAS0606	2CPX078161R9999		1
	800	ESAS0608	2CPX078162R9999		1
	1000	ESAS0610	2CPX078163R9999		1
	1200	ESAS0612	2CPX078164R9999		1
	1400	ESAS0614	2CPX078165R9999		1
	1600	ESAS0616	2CPX078166R9999		1
	1800	ESAS0618	2CPX078167R9999		1
	2000	ESAS0620	2CPX078168R9999		1
Width 800 mm					
	400	ESAS0804	2CPX078169R9999		1
	600	ESAS0806	2CPX078170R9999		1
	800	ESAS0808	2CPX078171R9999		1
	1000	ESAS0810	2CPX078172R9999		1
	1200	ESAS0810	2CPX078172R9999		1
	1400	ESAS0814	2CPX078174R9999		1
	1600	ESAS0816	2CPX078175R9999		1
	1800	ESAS0818	2CPX078176R9999		1
	2000	ESAS0820	2CPX078177R9999		1

- > Rear walls see page 18
- > Top and bottom plate see page 19
- > Side walls see page 20
- > Uprights for side-by-side positioning of cabinets see page 20
- > Installation set / internal cable container / mounting plates see page 21
- > Transparent doors see page 23
- > Flanges see page 24
- > Plinth see page 25
- > Lock replacement parts see page 26
- > General accessories see page 28

TwinLine S 43

Transparent doors



ESAT0612

Article	Height in mm	Type	Ord. no.	Price	Pcs.
Doors for wall-mounting cabinets, with latch plate and double bit 3 mm					
Doors for floor-standing cabinets, with swivel handle and double bit 3 mm					
Width 600 mm	600	ESAT0606	2CPX078178R9999		1
	800	ESAT0608	2CPX078179R9999		1
	1000	ESAT0610	2CPX078180R9999		1
	1200	ESAT0612	2CPX078181R9999		1
	1400	ESAT0614	2CPX078182R9999		1
	1600	ESAT0616	2CPX078183R9999		1
	1800	ESAT0618	2CPX078184R9999		1
	2000	ESAT0620	2CPX078185R9999		1
Width 800 mm	600	ESAT0806	2CPX078186R9999		1
	800	ESAT0808	2CPX078187R9999		1
	1000	ESAT0810	2CPX078188R9999		1
	1200	ESAT0812	2CPX078189R9999		1
	1400	ESAT0814	2CPX078190R9999		1
	1600	ESAT0816	2CPX078191R9999		1
	1800	ESAT0818	2CPX078192R9999		1
	2000	ESAT0820	2CPX078193R9999		1



ESAT2618

Width 800 mm	600	ESAT2606	2CPX078194R9999		1
For 800 mm wide cabinet	800	ESAT2608	2CPX078195R9999		1
With internal cable container	1000	ESAT2610	2CPX078196R9999		1
	1200	ESAT2612	2CPX078197R9999		1
	1400	ESAT2614	2CPX078198R9999		1
	1600	ESAT2616	2CPX078199R9999		1
	1800	ESAT2618	2CPX078200R9999		1
	2000	ESAT2620	2CPX078201R9999		1

- > Rear walls see page 18
- > Top and bottom plate see page 19
- > Side walls see page 20
- > Uprights for side-by-side positioning of cabinets see page 20
- > Installation set / internal cable container / mounting plates see page 21
- > Sheet steel doors see page 22
- > Flanges see page 24
- > Plinth see page 25
- > Lock replacement parts see page 26
- > General accessories see page 28

TwinLine S 43 Flanges

1



TZ101



TZ102



TZ103

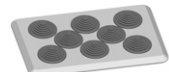

TZ110



TZ111

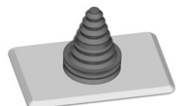

TZ112

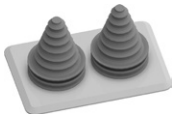

TZ104

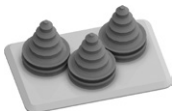

TZ105



TZ107



TZ106

Article	Type	Ord. no.	Price	Pcs.
Membrane flange	TZ101	2CPX010450R9999		1
Material: plastic	TZ101P10	2CPX010451R9999		10
For cable sections 2 x 6 - 32.5 mm, 2 x 6 - 25 mm, 4 x 6 - 19 mm, 10 x 6 - 15 mm, 2 x 6 - 12 mm, 31 x 6 - 11 mm, 1 x 6 - 7 mm	TZ101P100	2CPX010826R9999		100
Flanges for M screw fittings				
Material: plastic				
1 x M 63 / M 50, 2 x M 32 / M 20, 5 x M 25, 5 x M 20	TZ102	2CPX010452R9999		1
	TZ102P10	2CPX010453R9999		10
4 x M20 / M25, 18 x M20	TZ103	2CPX010454R9999		1
	TZ103P10	2CPX010455R9999		10
Flanges with cable sleeves				
Material: plastic				
Flanges with 8 cable sleeves	TZ110	2CPX010850R9999		1
For cable sections 8 x 13 - 34 mm	TZ110P10	2CPX010934R9999		10
Flanges with 11 cable sleeves	TZ111	2CPX010851R9999		1
For cable sections 1 x 14 - 54 mm, 3 x 13 - 34 mm, 3 x 13 - 26.5 mm, 4 x 5 - 21 mm	TZ111P10	2CPX010935R9999		10
Flange with 1 cable sleeve	TZ112	2CPX010852R9999		1
For cable sections 1 x 14 - 68 mm				
Flange with 2 cable sleeves	TZ104	2CPX010456R9999		1
For cable sections 2 x 14 - 68 mm	TZ104P10	2CPX010933R9999		10
Flange with 3 cable sleeves	TZ105	2CPX010457R9999		1
For cable sections 3 x 14 - 54 mm	TZ105P10	2CPX010933R9999		10
Closing flanges				
Material: plastic	TZ107	2CPX010460R9999		1
	TZ107P10	2CPX010461R9999		10
Material: sheet steel	TZ106	2CPX010458R9999		1
	TZ106P10	2CPX010459R9999		10

TwinLine S 43 Plinth



ESAG0605



ESAL0610

Article	Width mm	Type	Ord. No.	Price	Pcs.
Plinth, height 50 mm, color RAL 7012					
Depth 225 mm	300	ESAG0305	2CPX078202R9999		1
	600	ESAG0605	2CPX078204R9999		1
	800	ESAG0805	2CPX078206R9999		1
Depth 275 mm	300	ESAL0305	2CPX078208R9999		1
	600	ESAL0605	2CPX078210R9999		1
	800	ESAL0805	2CPX078212R9999		1
Plinth, height 100 mm, color RAL 7012					
Depth 225 mm	300	ESAG0310	2CPX078203R9999		1
Side knockouts	600	ESAG0610	2CPX078205R9999		1
1 x M 32 / M 50 or 80 x 80 mm	800	ESAG0810	2CPX078207R9999		1
Depth 275 mm	300	ESAL0310	2CPX078209R9999		1
Side knockouts	600	ESAL0610	2CPX078211R9999		1
1 x M 32 / M 50 or 80 x 80 mm	800	ESAL0810	2CPX078213R9999		1

- > Rear walls see page 18
- > Top and bottom plate see page 19
- > Side walls see page 20
- > Uprights for side-by-side positioning of cabinets see page 20
- > Installation set / internal cable container / mounting plates see page 21
- > Sheet steel doors see page 22
- > Transparent doors see page 23
- > Flanges see page 24
- > Lock replacement parts see page 26
- > General accessories see page 28

TwinLine S 43

Lock replacement parts

1

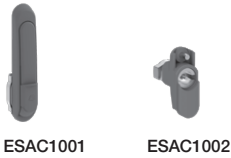

ESAC1001

ESAC1002



ESAC1003

ESAC1004



ESAC1005

ESAC1006



ESAC1007

ESAC1008

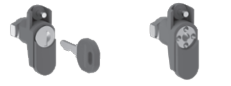

ESAC1009

ESAC1010



ESAC1011

ESAC1013



TZ517

TZ518



ZH130

ZH132



ZH134

ZH137

Article	Type	Ord. no.	Price	Pcs.
Swivel handle and operating pins				
Swivel handle with double bit 3 mm*1	ESAC1001	2CPX010900R9999		1
Double bit 3 mm*1	ESAC1002	2CPX010901R9999		1
Double bit 5 mm	ESAC1003	2CPX010902R9999		1
Triangular 7 mm	ESAC1004	2CPX010903R9999		1
Triangular 8 mm	ESAC1005	2CPX010904R9999		1
Square 6 mm	ESAC1006	2CPX010905R9999		1
Square 7 mm	ESAC1007	2CPX010906R9999		1
Square 8 mm	ESAC1008	2CPX010907R9999		1
EK333 and key	ESAC1009	2CPX010908R9999		1
FIST type insert (FIAT)	ESAC1010	2CPX010909R9999		1
FIAT key	ESAC1013	2CPX010912R9999		1
Ronis 455 and key	ESAC1011	2CPX010910R9999		1
Ronis 405 and key	ESAC1012	2CPX010911R9999		1
Latch plates and operating pins				
For operating pin 3 mm (standard)*2 and 5 mm	TZ517	2CPX010926R9999		1
For triangular and square operating pin	TZ518	2CPX010927R9999		1
Double bit 3 mm*2	ZH130	2CPX060490R9999		1
Double bit 5 mm	ZH131	2CPX060491R9999		1
Triangular 7 mm	ZH132	2CPX060492R9999		1
Triangular 8 mm	ZH133	2CPX060493R9999		1
Square 6 mm	ZH134	2CPX060494R9999		1
Square 7 mm	ZH135	2CPX060495R9999		1
Square 8 mm	ZH136	2CPX060496R9999		1
Daimler-Benz	ZH137	2CPX060497R9999		1

*1 In scope of delivery of doors for floor-standing cabinets

*2 In scope of delivery of doors for wall-mounting cabinets

TwinLine S 43

Lock replacement parts



ZH91



ZH160

ZH157



ZH162

ZH165



ESAC2004



ESAC2008

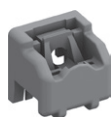

TZ511



TZ501

Article	Type	Ord. no.	Price	Pcs.
Universal key	ZH91	2CPX066091R9999		1
Double bit 3 mm/5 mm				
Triangular 8 mm, square 6 mm/8 mm				
Double bit 3 mm*	ZH160	2CPX060660R9999		1
Double bit 5 mm	ZH161	2CPX060661R9999		1
Triangular 7 mm	ZH157	2CPX060657R9999		1
Triangular 8 mm	ZH158	2CPX060658R9999		1
Square 6 mm	ZH162	2CPX060662R9999		1
Square 7 mm	ZH163	2CPX060663R9999		1
Square 8 mm	ZH164	2CPX060664R9999		1
Daimler-Benz	ZH165	2CPX060665R9999		1
Espagnolette closure*				
Closure for door height 400 mm	ESAC2004	2CPX010913R9999		1
Espagnolette closure height 600 mm	ESAC2006	2CPX010914R9999		1
Espagnolette closure height 800 mm	ESAC2008	2CPX010915R9999		1
Espagnolette closure height 1000 mm	ESAC2010	2CPX010916R9999		1
Espagnolette closure height 1200 mm	ESAC2012	2CPX010917R9999		1
Espagnolette closure height 1400 mm	ESAC2014	2CPX010918R9999		1
Espagnolette closure height 1600 mm	ESAC2016	2CPX010919R9999		1
Espagnolette closure height 1800 mm	ESAC2018	2CPX010920R9999		1
Espagnolette closure height 2000 mm	ESAC2020	2CPX010921R9999		1
Espagnolette guide*	TZ511	2CPX010495R9999		1
Shoe*	TZ501	2CPX010485R9999		1
For espagnolette closure				

*Accessory included in the scope of delivery

TwinLine S 43

General accessories

1



ESAC3001P2



ESAC3003P4



ESAC3004P2



TZ637



TZ628P10



ESAC3002



TZ626



TZ601



TZ604



TZ605

Article	Type	Ord. no.	Price	Pcs.
Mounting brackets 2 pcs* To mount the cabinet to the wall, to connect the plinth with the back of the cabinet or to connect cabinets in the back when using ESAC3002	ESAC3001P2	2CPX078410R9999		2
Transport lugs 4 pcs	ESAC3003P4	2CPX078412R9999		4
Lifting reinforcement for side-by-side structures 2 pcs For transporting side-by-side structures	ESAC3004P2	2CPX078413R9999		2
Door hinge: 180 degree* Colour: RAL7035	TZ637	2CPX078414R9999		1
Closing plugs for hinge cutout	TZ628P10	2CPX010854R9999		1
Connection set for stacking cabinets	ESAC3002	2CPX078411R9999		1
Protective frame for stacking cabinets	TZ626	2CPX010778R9999		1
Mounting rails* For mounting frame holder	TZ601	2CPX010779R9999		1
Mounting frame holder centre* For internal and external cable container	TZ604	2CPX010782R9999		1
Mounting frame holder* left or right	TZ605	2CPX010783R9999		1

*Accessory included in the scope of delivery

TwinLine S 43

General accessories



ZL8



CAEC6



ZA16



ZA116



ZA6



ZA5



ZA123

Article	Type	Ord. no.	Price	Pcs.
Door earthing set 10 mm ²	ZL8	2CPX038001R9999		1
Earthing set Connection between interior fitting and structure	CAEC6	2CPX078462R9999		1
Spray paint can Colour RAL 7035, 150 ml	ZA16	2CPX038235R9999		1
Touch-up applicator Colour RAL 7035, 12 ml	ZA116	2CPX039042R9999		1
Document holder DIN A4 Self-adhesive with transparent sleeve	ZA6	2CPX038227R9999		1
Self-adhesive with transparent sleeve	ZA6P10	2CPX062380R9999		10
Self-adhesive with transparent sleeve and reinforced back	ZA61P10	2CPX062375R9999		10
Document holder DIN A4 Self-adhesive	ZA13	2CPX038233R9999		1
Self-adhesive	ZA13P10	2CPX062381R9999		10
Document holder DIN A5 Self-adhesive	ZA5	2CPX038228R9999		1
Self-adhesive	ZA5P10	2CPX062382R9999		10
Document holder support plate For document holder ZA13. to screw on to the door strengthening profiles	ZA123	2CPX038471R9999		1
For document holder ZA5. to screw on to the door strengthening profiles	ZA125	2CPX038472R9999		1

TwinLine S 43

Dimensions of cabinets

1

Front view
Wall-mounting and floor-standing cabinet
External/internal dimensions

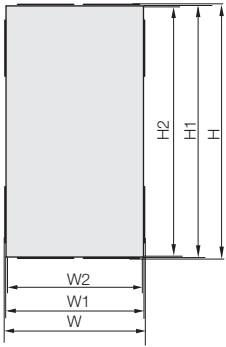

Front view
Wall-mounting cabinet
Wall fastening dimensions

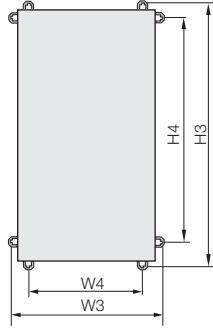

Front view
Floor-standing cabinet
Wall fastening dimensions

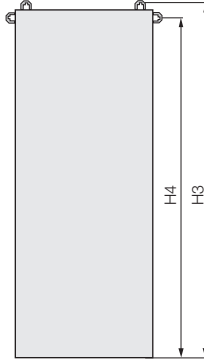

Front view
External fastening
Detail

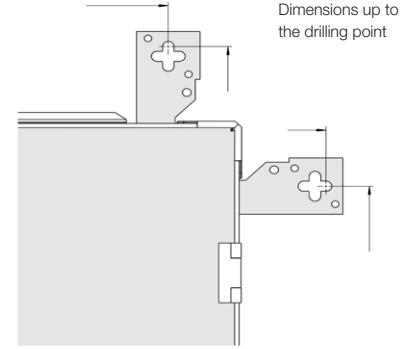

Cabinet types H x W x D	External dimensions in mm			Internal dimensions in mm		External dimensions with embossing in mm		Wall fastening dimensions in mm			
	H1	W1	D1	H2	W2	H	W	H3	W3	H4	W4
400 x 300 x 225	450	390	225	402	342	454	394	578.5	518.5	345	285
600 x 300 x 225	650	390	225	602	342	654	394	778.5	518.5	545	285
800 x 300 x 225	850	390	225	802	342	854	394	978.5	518.5	745	285
1000 x 300 x 225	1050	390	225	1002	342	1054	394	1178.5	518.5	945	285
1200 x 300 x 225	1250	390	225	1202	342	1254	394	1378.5	518.5	1145	285
1400 x 300 x 225	1450	390	225	1402	342	1454	394	1514	518.5	1399.5	285
1600 x 300 x 225	1650	390	225	1602	342	1654	394	1714	518.5	1599.5	285
1800 x 300 x 225	1850	390	225	1802	342	1854	394	1914	518.5	1799.5	285
2000 x 300 x 225	2050	390	225	2002	342	2054	394	2114	518.5	1999.5	285
400 x 600 x 225	450	660	225	402	612	454	664	578.5	788.5	345	555
600 x 600 x 225	650	660	225	602	612	654	664	778.5	788.5	545	555
800 x 600 x 225	850	660	225	802	612	854	664	978.5	788.5	745	555
1000 x 600 x 225	1050	660	225	1002	612	1054	664	1178.5	788.5	945	555
1200 x 600 x 225	1250	660	225	1202	612	1254	664	1378.5	788.5	1145	555
1400 x 600 x 225	1450	660	225	1402	612	1454	664	1514	788.5	1399.5	555
1600 x 600 x 225	1650	660	225	1602	612	1654	664	1714	788.5	1599.5	555
1800 x 600 x 225	1850	660	225	1802	612	1854	664	1914	788.5	1799.5	555
2000 x 600 x 225	2050	660	225	2002	612	2054	664	2114	788.5	1999.5	555
400 x 800 x 225	450	875	225	402	827	454	879	578.5	1003.5	345	770
600 x 800 x 225	650	875	225	602	827	654	879	778.5	1003.5	545	770
800 x 800 x 225	850	875	225	802	827	854	879	978.5	1003.5	745	770
1000 x 800 x 225	1050	875	225	1002	827	1054	879	1178.5	1003.5	945	770
1200 x 800 x 225	1250	875	225	1202	827	1254	879	1378.5	1003.5	1145	770
1400 x 800 x 225	1450	875	225	1402	827	1454	879	1514	1003.5	1399.5	770
1600 x 800 x 225	1650	875	225	1602	827	1654	879	1714	1003.5	1599.5	770
1800 x 800 x 225	1850	875	225	1802	827	1854	879	1914	1003.5	1799.5	770
2000 x 800 x 225	2050	875	225	2002	827	2054	879	2114	1003.5	1999.5	770

> Dimensions in mm

TwinLine S 43

Power loss and weights of cabinets

Type of installation
Separate cabinet wall mounted

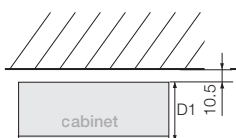

Type of installation
First or last cabinet wall mounted

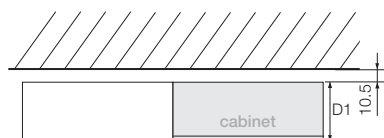

Type of installation
Central cabinet wall mounted

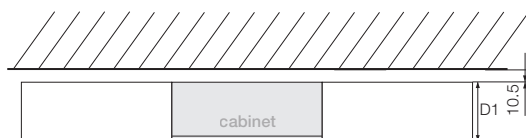

Cabinet types H x W x D	Power loss in Watt*												Cabinet weight in kg		max. installation weight in kg
	Separate cabinet wall mounted				First or last cabinet wall mounted				Central cabinet wall mounted				With door	Without door	
	25 °C	30 °C	35 °C	40 °C	25 °C	30 °C	35 °C	40 °C	25 °C	30 °C	35 °C	40 °C			
400 x 300 x 225	46	58	70	82	43	54	65	77	40	50	60	71	13.55	8.80	10
600 x 300 x 225	58	73	89	105	54	68	82	97	50	62	76	89	17.50	10.88	15
800 x 300 x 225	71	89	108	127	66	82	100	118	60	76	91	108	21.11	13.30	20.5
1000 x 300 x 225	84	105	127	150	77	97	117	138	71	89	107	127	24.75	15.03	31.5
1200 x 300 x 225	87	109	132	155	89	112	135	160	81	102	124	146	28.59	17.10	37.5
1400 x 300 x 225	90	112	136	161	91	115	139	164	92	115	140	165	32.67	19.17	43
1600 x 300 x 225	93	116	141	166	94	117	142	168	94	118	143	169	36.29	21.24	49
1800 x 300 x 225	106	133	160	189	96	120	146	172	96	121	146	173	39.90	23.32	60
2000 x 300 x 225	120	151	182	215	108	136	164	194	98	123	149	176	43.52	25.38	72
400 x 600 x 225	70	88	107	126	67	84	102	120	64	80	97	115	18.50	11.55	22
600 x 600 x 225	86	108	131	155	82	103	125	147	78	97	118	139	23.72	14.26	30
800 x 600 x 225	91	115	139	164	87	109	133	157	92	115	139	165	28.60	16.96	41
1000 x 600 x 225	96	121	146	173	92	116	140	166	96	120	146	172	33.51	19.68	63.5
1200 x 600 x 225	111	139	168	199	104	130	158	187	100	125	152	179	38.62	22.38	75
1400 x 600 x 225	124	156	189	223	118	148	179	212	111	139	168	199	43.97	25.09	86
1600 x 600 x 225	146	183	222	262	136	170	206	244	129	162	196	231	48.87	27.80	97
1800 x 600 x 225	167	210	254	300	159	199	242	285	147	185	224	264	53.75	30.50	120
2000 x 600 x 225	188	236	286	338	177	221	268	317	169	211	256	302	58.65	33.22	132
400 x 800 x 225	90	113	136	161	86	108	131	155	83	104	126	149	22.46	13.76	35
600 x 800 x 225	91	115	139	164	89	112	136	160	102	128	154	182	28.69	16.97	45
800 x 800 x 225	110	138	168	198	107	135	163	192	106	133	162	191	34.59	20.18	61.5
1000 x 800 x 225	132	166	201	237	125	157	190	225	121	152	185	218	40.50	23.40	95.5
1200 x 800 x 225	153	192	233	275	146	183	221	261	142	178	215	254	46.63	26.61	112.5
1400 x 800 x 225	177	222	269	318	170	214	259	306	162	204	247	291	53.00	29.83	129
1600 x 800 x 225	191	240	291	343	182	228	277	327	176	221	268	316	58.90	33.04	145
1800 x 800 x 225	215	269	326	385	207	259	314	371	201	252	305	361	64.79	36.25	180
2000 x 800 x 225	238	299	362	428	230	289	350	413	223	280	339	400	70.70	39.47	196

* Powerloss determined by calculation with the method of IEC 60890 in accordance with IEC 61439-1 par. 10.10.4

> Dimensions in mm

TwinLine S 43

Dimensions of cabinets

1

Front view
Wall-mounting and floor-standing cabinet
External/internal dimensions

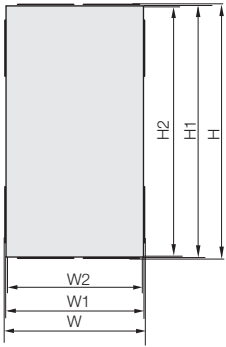

Front view
Wall-mounting cabinet
Wall fastening dimensions

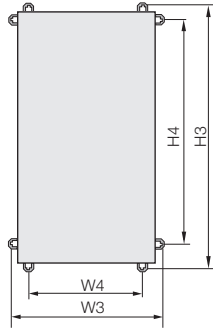

Front view
Floor-standing cabinet
Wall fastening dimensions

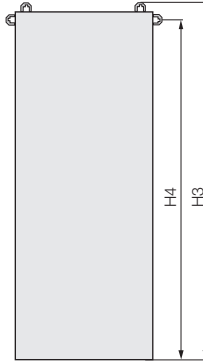

Front view
External fastening
Detail

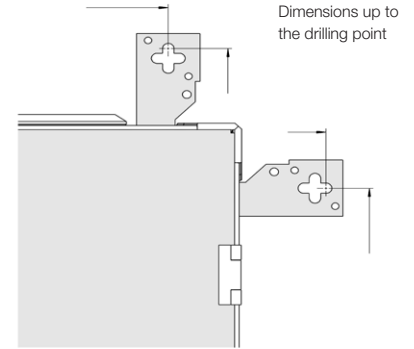

Cabinet types H x W x D	External dimensions in mm			Internal dimensions in mm		External dimensions with embossing in mm		Wall fastening dimensions in mm			
	H1	W1	D1	H2	W2	H	W	H3	W3	H4	W4
400 x 300 x 275	450	390	275	402	342	454	394	578.5	518.5	345	285
600 x 300 x 275	650	390	275	602	342	654	394	778.5	518.5	545	285
800 x 300 x 275	850	390	275	802	342	854	394	978.5	518.5	745	285
1000 x 300 x 275	1050	390	275	1002	342	1054	394	1178.5	518.5	945	285
1200 x 300 x 275	1250	390	275	1202	342	1254	394	1378.5	518.5	1145	285
1400 x 300 x 275	1450	390	275	1402	342	1454	394	1514	518.5	1399.5	285
1600 x 300 x 275	1650	390	275	1602	342	1654	394	1714	518.5	1599.5	285
1800 x 300 x 275	1850	390	275	1802	342	1854	394	1914	518.5	1799.5	285
2000 x 300 x 275	2050	390	275	2002	342	2054	394	2114	518.5	1999.5	285
400 x 600 x 275	450	660	275	402	612	454	664	578.5	788.5	345	555
600 x 600 x 275	650	660	275	602	612	654	664	778.5	788.5	545	555
800 x 600 x 275	850	660	275	802	612	854	664	978.5	788.5	745	555
1000 x 600 x 275	1050	660	275	1002	612	1054	664	1178.5	788.5	945	555
1200 x 600 x 275	1250	660	275	1202	612	1254	664	1378.5	788.5	1145	555
1400 x 600 x 275	1450	660	275	1402	612	1454	664	1514	788.5	1399.5	555
1600 x 600 x 275	1650	660	275	1602	612	1654	664	1714	788.5	1599.5	555
1800 x 600 x 275	1850	660	275	1802	612	1854	664	1914	788.5	1799.5	555
2000 x 600 x 275	2050	660	275	2002	612	2054	664	2114	788.5	1999.5	555
400 x 800 x 275	450	875	275	402	827	454	879	578.5	1003.5	345	770
600 x 800 x 275	650	875	275	602	827	654	879	778.5	1003.5	545	770
800 x 800 x 275	850	875	275	802	827	854	879	978.5	1003.5	745	770
1000 x 800 x 275	1050	875	275	1002	827	1054	879	1178.5	1003.5	945	770
1200 x 800 x 275	1250	875	275	1202	827	1254	879	1378.5	1003.5	1145	770
1400 x 800 x 275	1450	875	275	1402	827	1454	879	1514	1003.5	1399.5	770
1600 x 800 x 275	1650	875	275	1602	827	1654	879	1714	1003.5	1599.5	770
1800 x 800 x 275	1850	875	275	1802	827	1854	879	1914	1003.5	1799.5	770
2000 x 800 x 275	2050	875	275	2002	827	2054	879	2114	1003.5	1999.5	770

> Dimensions in mm

TwinLine S 43

Power loss and weights of cabinets

Type of installation
Separate cabinet wall mounted

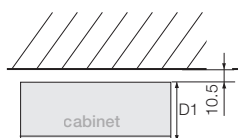

Type of installation
First or last cabinet wall mounted

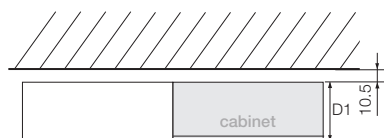

Type of installation
Central cabinet wall mounted

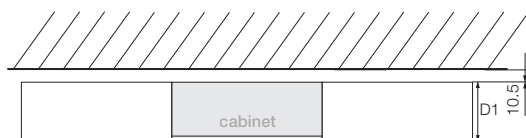

Cabinet types H x W x D	Power loss in Watt*												Cabinet weight in kg		max. installation weight in kg
	Separate cabinet wall mounted				First or last cabinet wall mounted				Central cabinet wall mounted				With door	Without door	
	25 °C	30 °C	35 °C	40 °C	25 °C	30 °C	35 °C	40 °C	25 °C	30 °C	35 °C	40 °C			
400 x 300 x 275	51	64	78	92	47	59	72	85	43	55	66	78	14.31	9.57	10
600 x 300 x 275	64	81	98	116	59	74	90	106	54	68	82	97	18.41	11.79	15
800 x 300 x 275	78	98	119	140	72	90	109	129	65	82	99	117	22.18	14.02	20.5
1000 x 300 x 275	92	115	140	165	84	106	128	151	76	96	116	137	25.97	16.25	31.5
1200 x 300 x 275	96	121	146	173	87	110	133	157	87	110	133	157	29.97	18.48	37.5
1400 x 300 x 275	100	126	152	180	91	114	138	163	90	113	137	162	34.21	20.71	43
1600 x 300 x 275	105	131	159	188	94	118	143	169	93	117	142	167	37.99	22.94	49
1800 x 300 x 275	120	151	183	216	107	134	163	192	96	121	146	173	41.75	25.17	60
2000 x 300 x 275	136	170	206	243	122	152	185	218	107	135	163	193	45.53	27.39	72
400 x 600 x 275	77	97	118	139	73	92	112	132	69	87	105	125	19.47	12.52	22
600 x 600 x 275	94	118	143	169	89	111	135	159	84	105	127	150	24.84	15.38	30
800 x 600 x 275	95	119	145	171	90	112	136	161	86	108	131	155	29.88	18.24	41
1000 x 600 x 275	109	137	166	196	103	129	156	185	99	125	151	178	34.94	21.11	63.5
1200 x 600 x 275	128	161	195	230	118	148	180	212	111	139	169	199	40.22	23.98	75
1400 x 600 x 275	146	183	222	262	135	169	205	242	128	160	194	229	45.72	26.84	86
1600 x 600 x 275	162	203	246	291	150	188	228	269	139	174	211	249	50.77	29.70	97
1800 x 600 x 275	184	230	279	330	171	215	260	307	161	202	245	289	55.82	32.57	120
2000 x 600 x 275	205	258	312	368	193	242	293	346	180	225	273	322	60.87	35.44	132
400 x 800 x 275	98	123	149	176	94	118	143	169	90	113	137	161	23.60	14.89	35
600 x 800 x 275	103	129	157	185	100	125	151	179	98	123	149	176	29.98	18.26	45
800 x 800 x 275	125	156	189	224	120	150	182	215	117	147	178	210	36.04	21.63	61.5
1000 x 800 x 275	150	188	227	268	143	179	217	257	137	172	208	246	42.11	25.01	95.5
1200 x 800 x 275	177	222	269	318	165	207	251	296	158	198	239	283	48.40	28.38	112.5
1400 x 800 x 275	199	250	303	357	189	237	287	339	183	230	278	328	54.92	31.75	129
1600 x 800 x 275	222	278	337	398	212	266	323	381	202	253	307	362	60.98	35.12	145
1800 x 800 x 275	233	292	353	417	221	277	336	396	213	267	323	382	67.02	38.48	180
2000 x 800 x 275	254	319	386	456	244	307	372	439	236	296	359	424	73.09	41.86	196

* Powerloss determined by calculation with the method of IEC 60890 in accordance with IEC 61439-1 par. 10.10.4

> Dimensions in mm

TwinLine S 43

Dimensions and weights – sheet steel doors

External dimensions

Dimensions of usable connection area

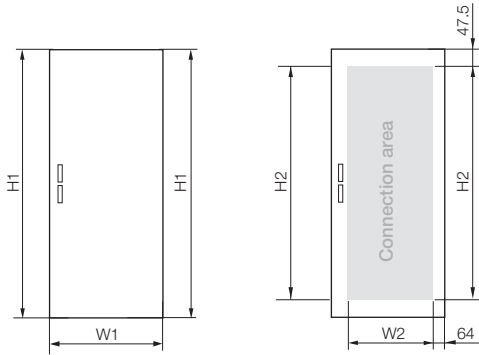

Sheet steel doors Type	External dimensions Height x width in mm		Internal dimensions Height x width in mm		Weight in kg	max. installation weight in kg
	H1	W1	H2	W2		
ESAS0304	443	379	348	213	4.75	5
ESAS0306	643	379	548	213	6.62	5
ESAS0308	843	379	748	213	7.81	5
ESAS0310	1043	379	948	213	9.72	5
ESAS0312	1243	379	1148	213	11.49	5
ESAS0314	1443	379	1348	213	13.50	5
ESAS0316	1643	379	1548	213	15.05	5
ESAS0318	1843	379	1748	213	16.58	5
ESAS0320	2043	379	1948	213	18.14	5
ESAS0604	443	649	348	483	6.95	5
ESAS0606	643	649	548	483	9.46	5
ESAS0608	843	649	748	483	11.64	5
ESAS0610	1043	649	948	483	13.83	5
ESAS0612	1243	649	1148	483	16.24	5
ESAS0614	1443	649	1348	483	18.88	5
ESAS0616	1643	649	1548	483	21.07	5
ESAS0618	1843	649	1748	483	23.25	5
ESAS0620	2043	649	1948	483	25.43	5
ESAS0804	443	864	348	698	8.70	7.5
ESAS0806	643	864	548	698	11.72	7.5
ESAS0808	843	864	748	698	14.41	7.5
ESAS0810	1043	864	948	698	17.10	7.5
ESAS0810	1243	864	1148	698	20.02	7.5
ESAS0814	1443	864	1348	698	23.17	7.5
ESAS0816	1643	864	1548	698	25.86	7.5
ESAS0818	1843	864	1748	698	28.54	7.5
ESAS0820	2043	864	1948	698	31.23	7.5

> Dimensions in mm

TwinLine S 43

Dimensions and weights – transparent doors

External dimensions

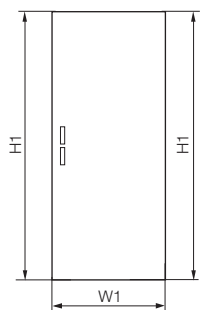

Dimensions of viewing area

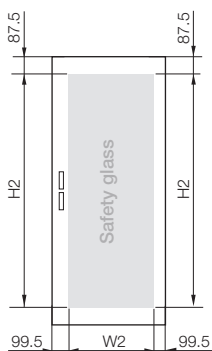

Transparent doors Type	External dimensions Height x width in mm		Viewing area Height x width in mm		Weight in kg
	H1	W1	H2	W2	
ESAT0606	643	649	468	450	9.63
ESAT0608	843	649	668	450	11.67
ESAT0610	1043	649	868	450	13.7
ESAT0612	1243	649	1068	450	15.96
ESAT0614	1443	649	1268	450	18.36
ESAT0616	1643	649	1468	450	20.4
ESAT0618	1843	649	1668	450	22.43
ESAT0620	2043	649	1868	450	24.46
ESAT0806	643	864	468	665	11.85
ESAT0808	843	864	668	665	14.3
ESAT0810	1043	864	868	665	16.74
ESAT0812	1243	864	1068	665	19.4
ESAT0814	1443	864	1268	665	22.23
ESAT0816	1643	864	1468	665	24.67
ESAT0818	1843	864	1668	665	27.12
ESAT0820	2043	864	1868	665	29.56
ESAT2606	643	864	468	450	11.66
ESAT2608	843	864	668	450	14.2
ESAT2610	1043	864	868	450	16.47
ESAT2612	1243	864	1068	450	19.5
ESAT2614	1443	864	1268	450	22.42
ESAT2616	1643	864	1468	450	24.96
ESAT2618	1843	864	1668	450	27.5
ESAT2620	2043	864	1868	450	30

> Dimensions in mm

TwinLine S 43

Dimensions and weights – mounting plate

1

External dimensions / Usable connection area
Mounting plate

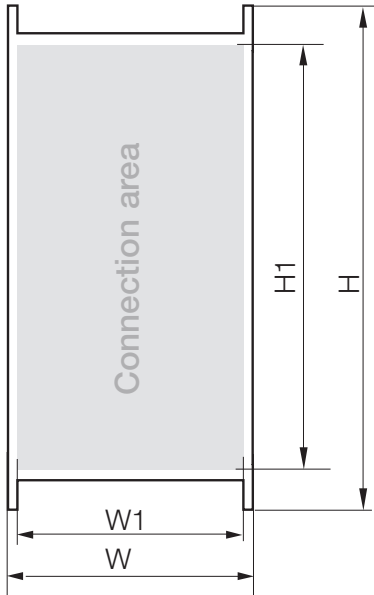

Type	External dimensions Height x width in mm		Internal dimensions Height x width in mm		Weight in kg
	H	W	H1	W1	
TZM204	600	496	522	410	3.51
TZM304	600	746	522	660	8.07
TZM208	1200	496	1122	410	11.82
TZM308	1200	746	1122	660	16.45
RM28	1800	496	1722	410	17.8
RM38	1800	746	1722	660	21

> Dimensions in mm

TwinLine S 43

Dimensions and weights – plinth

External/internal dimensions

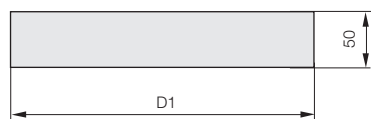
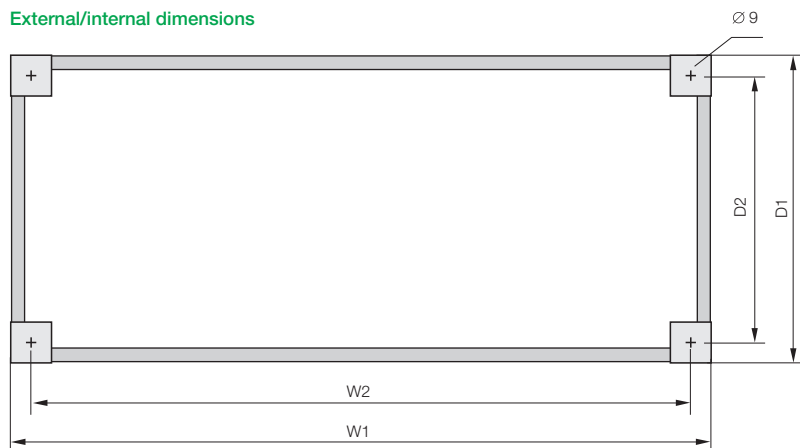

View side knockout TwinLine-G and -L

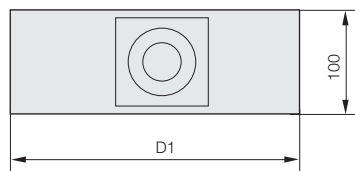

Detail view for side knockout

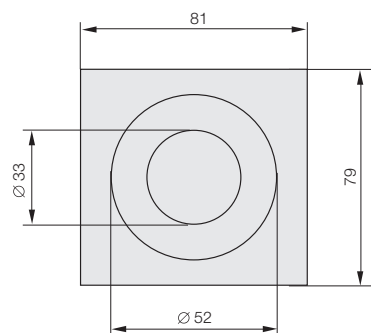

Type	External dimensions Width x depth in mm		Internal dimensions Width x depth in mm		Weight in kg
	W1	D1	W2	D2	
Plinth height 50 mm					
ESAL0305	390	253.5	360	223.5	1.57
ESAL0605	660	253.5	630	223.5	2.10
ESAL0805	875	253.5	845	223.5	2.53
ESAG0305	390	203.5	360	173.5	1.44
ESAG0605	660	203.5	630	173.5	1.98
ESAG0805	875	203.5	845	173.5	2.41
Plinth height 100 mm					
ESAL0310	390	253.5	360	223.5	2.59
ESAL0610	660	253.5	630	223.5	3.45
ESAL0810	875	253.5	845	223.5	4.13
ESAG0310	390	203.5	360	173.5	2.41
ESAG0610	660	203.5	630	173.5	3.27
ESAG0810	875	203.5	845	173.5	3.95

> Dimensions in mm

TwinLine S 43

Side view assembly with mounting plate

1

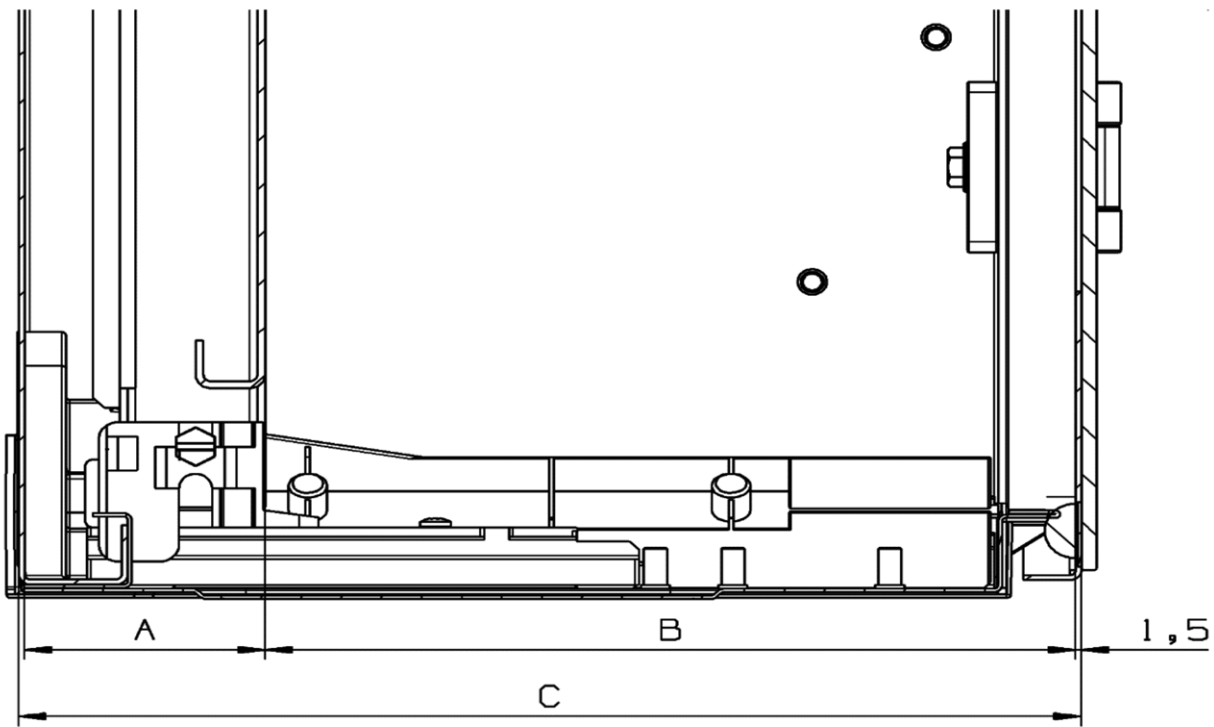

Cabinet series	Depth (C) in mm	A in mm for installation position					
		Pos 3	Pos 2	Pos 1	Pos 0	Pos -1	Pos -2
TwinLine G	225	63	75.5	88	100.5	113	125.5
TwinLine L	275	63	75.5	88	100.5	113	125.5
Cabinet series	Depth (C) in mm	B in mm for installation position					
TwinLine G	225	159	146.5	134	121.5	109	96.5
TwinLine L	275	209	196.5	184	171.5	159	146.5

TwinLine S 43

Side view with CombiLine S for 225 mm und 275 mm depth

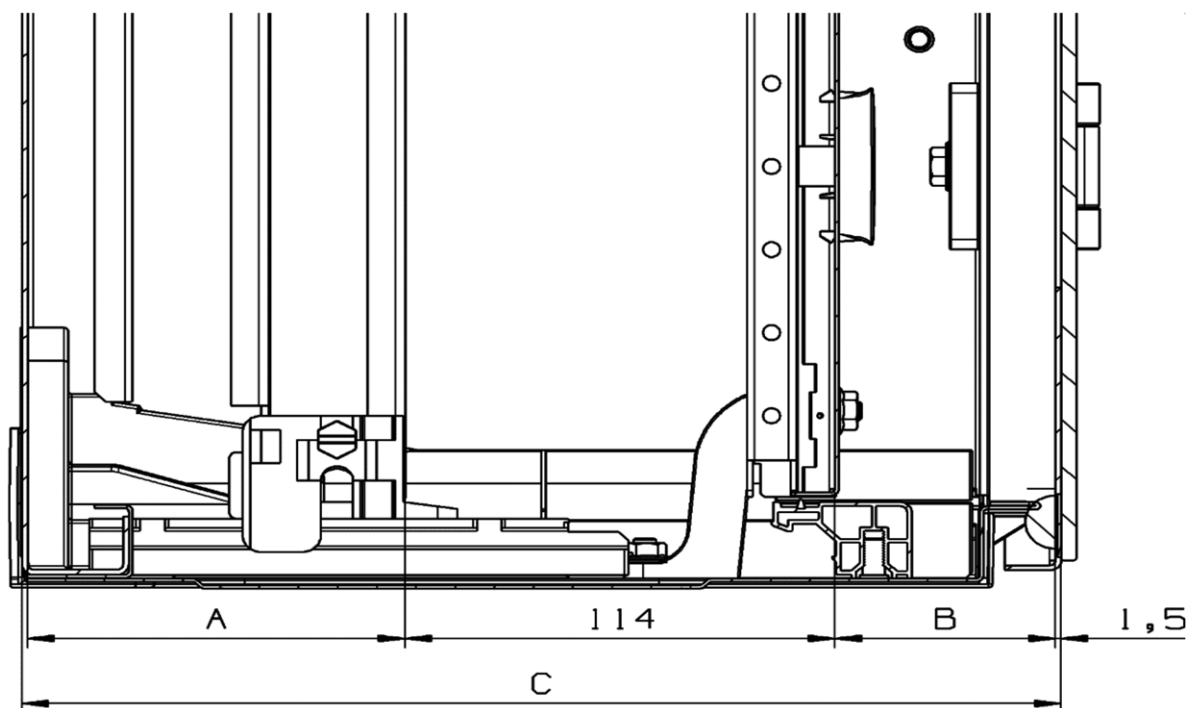

	Depth (C) in mm	A in mm	B in mm
TwinLine G	225	62	46
TwinLine L	275	100	58

TwinLine S 43

Top and bottom view - flange openings

1

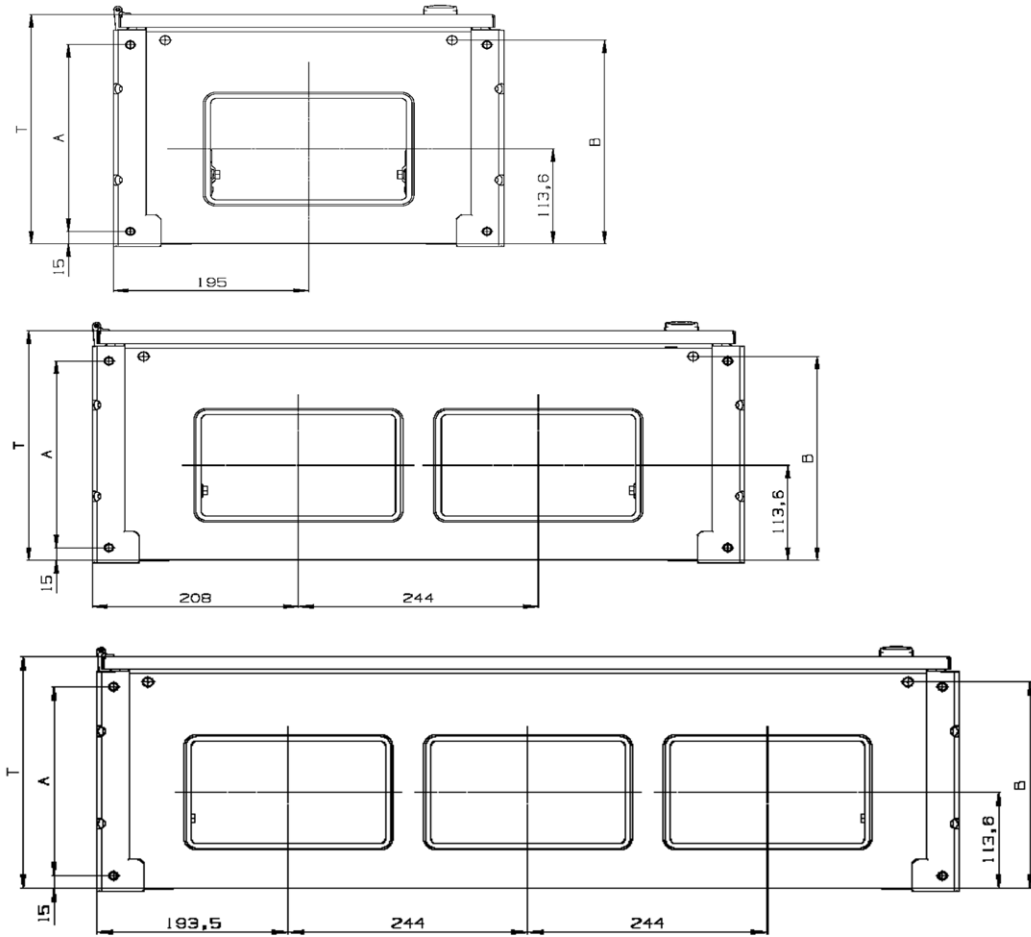

Depth in mm	A in mm	B in mm
225	173.5	170
275	223.5	244

TwinLine S 43

Transport by crane

Lifting of the TwinLine enclosures is possible as indicated.
Always use the STRIEBEL & JOHN transportation lugs type ESAC3003P4
and for side-by-side structures lifting reinforcement ESAC3004P2.
Also consider the weight limits of the cabinets.

1

max. 190 kg

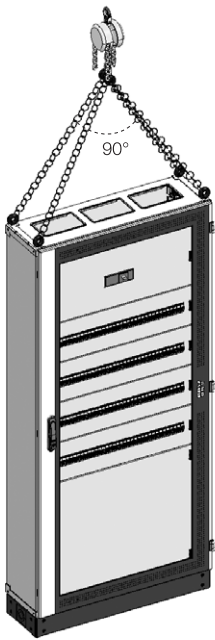

max. 300 kg

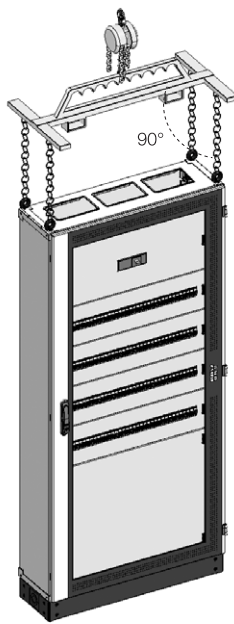

max. 360 kg

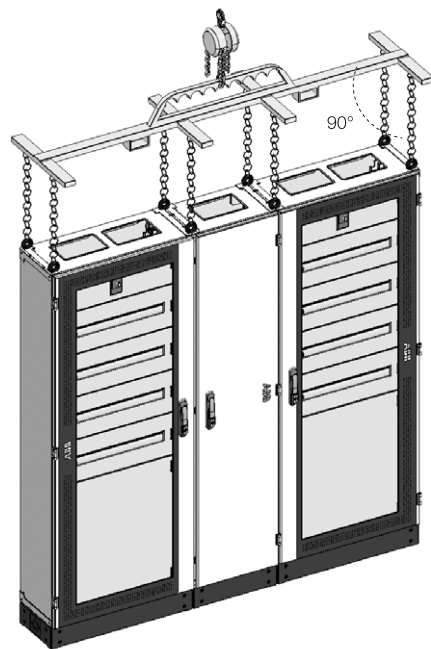

max. cabinet combinations
800 + 300 + 800 mm, wide cabinets

System pro *E* combi

CombiLine S distribution panel system

Simple in planning

Quick in assembly

2

Safe in application

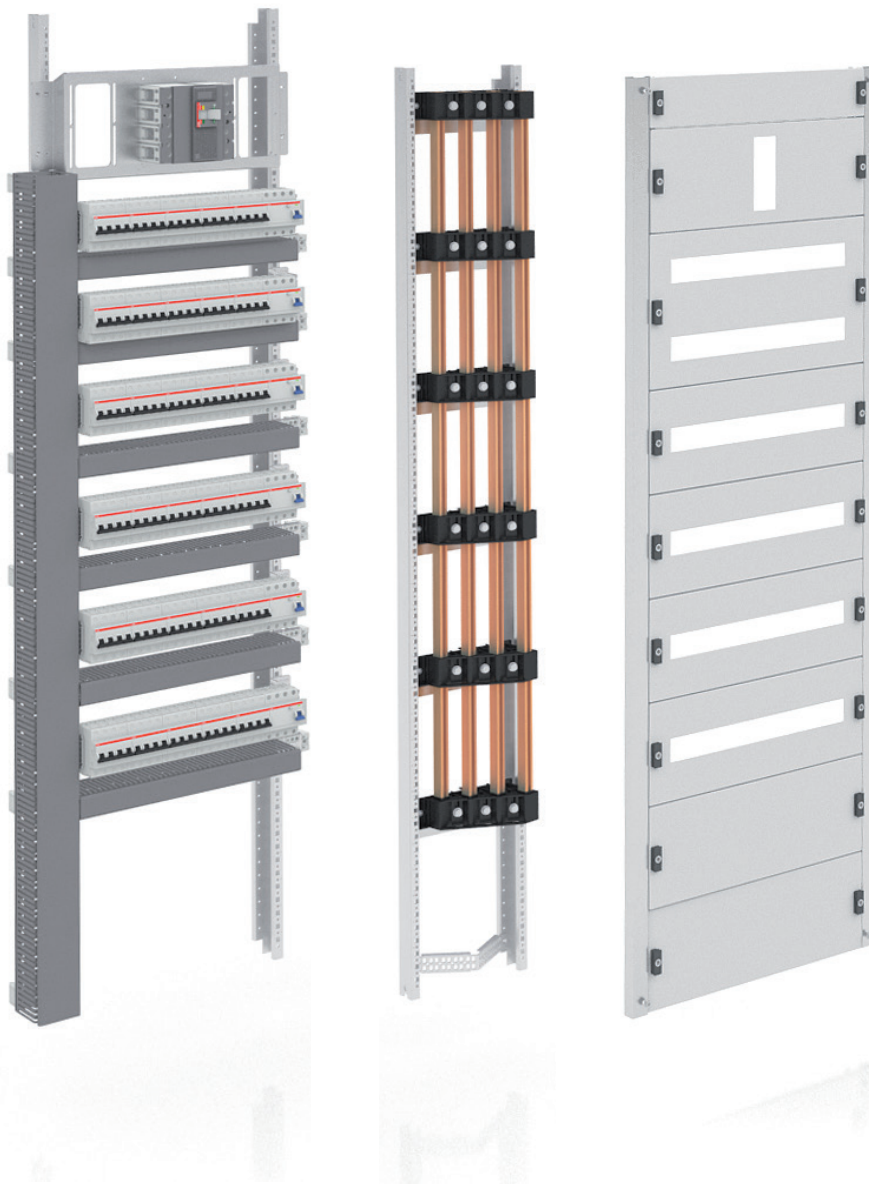

System pro E combi

CombiLine S distribution panel system

The highly sophisticated quick mounting system from ABB makes the completion of modular cabinets with distribution panels an effortless process. Simple, quick and safe – these are the three attributes of this system that speak for themselves.

TwinLine makes internal configuration fun, with a modular system of wall-mounting and floor-standing cabinets for the modular CombiLine S distribution panel system. The wide range of the CombiLine S offers the right solution for every application. One internal configuration System for all cabinets.

All of the individual parts required for assembling are packed separately and supplied in the form of a set.

The benefits: These sets allow you to take a flexible approach towards stock keeping, and avoid a time-consuming search for system parts such as brackets, screws or fastening elements. The instructions supplied with the system make assembly a child's play. Quick and clear planning and calculation become perfect with planning software.

CombiLine S distribution panel system

Product benefits

2



One internal configuration system for all cabinets

All internal configuration and the busbar system for the cable containers up to 400 A fits in both cabinet depths. The internal configuration up to 800 A and the busbar system behind the device area also fits in a 275 mm cabinet depth.



Flexible in assembling

With its new mounting concept CombiLine S provides more flexibility and access for installation and wiring. Placed horizontally on two trestles, the assembly and wiring is very comfortable. An other option is to swing-out the whole internal configuration to have access from all sides.

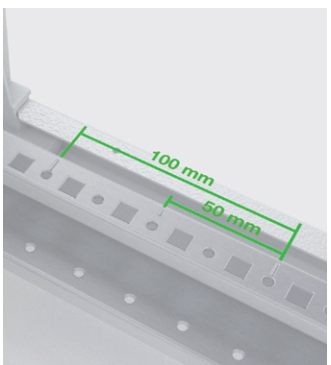

Assembly of internal configuration

CombiLine S provide a time-saving installation due the hook-in technology. This quick assembly limits the numbers of screws. Markers in 50 mm grid are on the mounting profiles for simple positioning.



Easy handling of covers

Time-saving fixation and adjustment as well as the simple closure system with 1/4 turn quick-lock provides easy handling of the covers and standard earth connection. When using devices in the covers a safe earth connection is guaranteed through 6 mm² cable with ring shoes on both sides. Optimal accessibility give the hinge set with 90 degree opening angle.

CombiLine S distribution panel system

Product benefits

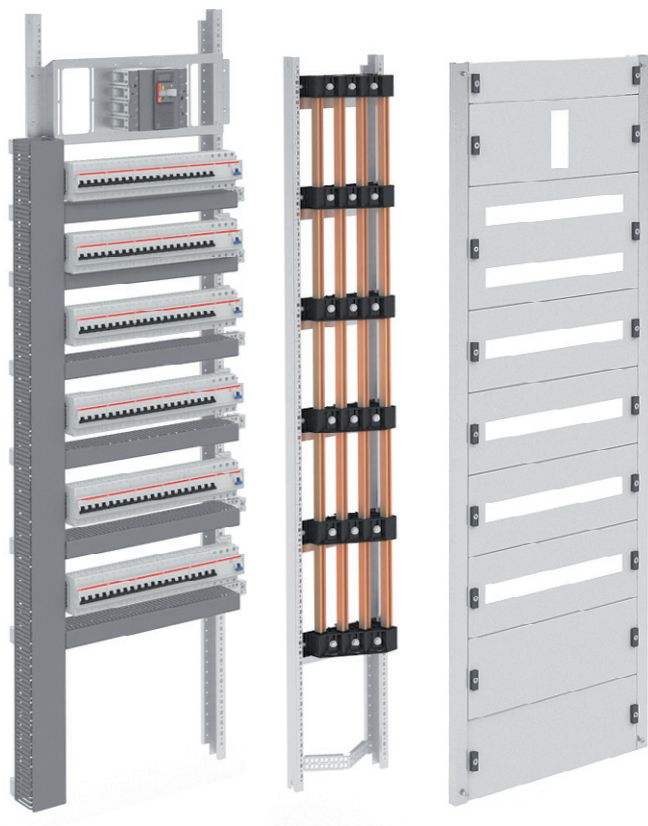

Optimal accessibility and ease of installation

The removable frame as standard gives the possibility to remove all covers in one handling and provides a quick access.

2

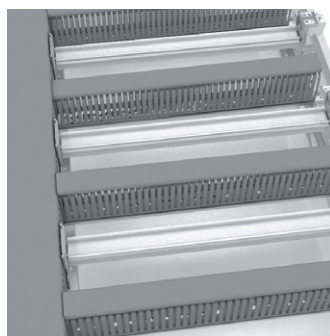
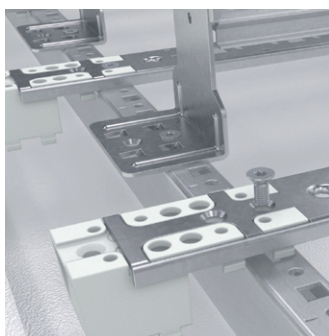

Wiring system

One support for different dimensions of wiring ducts; to have the same level for horizontal and vertical usage. An additional profile for stabilization of wiring duct and for mounting wire holders is available.

Form of internal separation up to form 2b

For the busbar system behind the device area is a horizontal transparent partition available. To separate the busbar system in external cable container it is possible to use a vertical separation.

CombiLine S distribution panel system

The right module for every type of Application

2



Tmax breakers

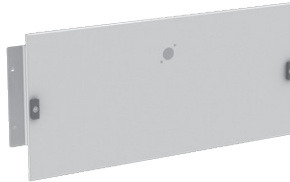

OT breakers

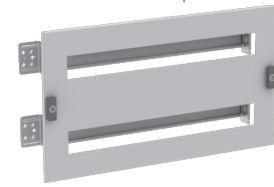

DIN rail components

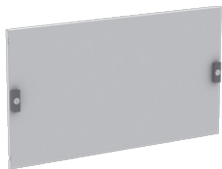

Standard covers



Covers for measuring instruments



Mounting plates



Internal form of separation form 2b



Busbar systems

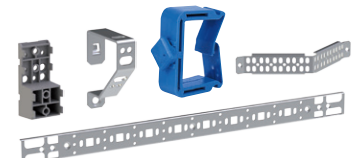

Accessories

- > Tmax breakers see page 48
- > OT switch connector see page 52
- > DIN rail components see page 54
- > Covers closed see page 56
- > Covers for measuring instruments see page 57
- > Mounting plates see page 58
- > Internal form of separation Form 2b see page 59
- > Busbar system see page 60
- > Accessories see page 64

CombiLine S distribution panel system

Technical specifications

Technical specifications

Standards / regulations	IEC 61439 -1/-2/-3
Protection class	I, earthed
Degree of protection	IPXXC

Electrical characteristics

Rated impulse withstand voltage (U_{imp})	6 kV
Overvoltage category	III
Pollution degree	3
Rated current (I_n)	up to 800 A
Rated peak withstand current (I_{pk})	up to 67 kA
Rated short-time withstand current (I_{cw}) 1.0 sec.	up to 32 kA
Rated frequency (f)	50 - 60 Hz
Rated insulation voltage (U)	1000 V
Rated operational voltage (U_o)	690 V

CombiLine S distribution panel system

Moulded case circuit breaker Tmax, horizontal

2



CHCC1511



CHDC1511

Tmax breaker horizontal 3-/4-pole

- Unequipped set for ABB Tmax as an incomer or outgoing breaker
- For fixed version with lever operation and front terminals
- Sheet steel cover with cut-out for 3*-/4-pole breaker
- Cover with 1/4 turn quick-lock

Width mm	Height mm	For device				Minimum cabinet depth	Type	Ord. no.	Price	Pcs.
		I_n max A	Type	Numbers of breakers	Numbers of poles					
600	150	160	Tmax XT1	1	3/4	225	CHCA1511	2CPX078241R9999		1
	200	160	Tmax XT2	1	3/4	225	CHCB1511	2CPX078242R9999		1
	200	250	Tmax XT3	1	3/4	225	CHCC1511	2CPX078243R9999		1
	200	250	Tmax XT4	1	3/4	225	CHCD1511	2CPX078244R9999		1
	200	320	Tmax T4	1	3/4	225	CHCE1511	2CPX078245R9999		1
	300	630	Tmax T5	1	3/4	275	CHCF1511	2CPX078246R9999		1
	400	800	Tmax T6	1	3/4	275	CHCG1511	2CPX078247R9999		1
800	150	160	Tmax XT1	1	3/4	225	CHDA1511	2CPX078248R9999		1
	200	160	Tmax XT2	1	3/4	225	CHDB1511	2CPX078249R9999		1
	200	250	Tmax XT3	1	3/4	225	CHDC1511	2CPX078250R9999		1
	200	250	Tmax XT4	1	3/4	225	CHDD1511	2CPX078251R9999		1
	200	320	Tmax T4	1	3/4	225	CHDE1511	2CPX078252R9999		1
	300	630	Tmax T5	1	3/4	275	CHDF1511	2CPX078253R9999		1
	400	800	Tmax T6	1	3/4	275	CHDG1511	2CPX078254R9999		1

*For 3 poles breakers please order accessory flange codes: AD3305 XT1 3P Flange for plate-mounting - AD3306 XT2 3P Flange for plate-mounting - AD3307 XT3 3P Flange for plate-mounting - AD3308 XT4 3P Flange for plate-mounting.

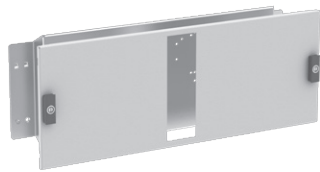

CHCC1611



CHDC1611

Tmax breaker horizontal 4-pole + RC sel.

- Unequipped set for ABB Tmax as an incomer or outgoing breaker
- For fixed version with lever operation and front terminals
- Sheet steel cover with cut-out for 4-pole breaker and RC Sel.
- Cover with 1/4 turn quick-lock

Width mm	Height mm	For device				Minimum cabinet depth	Type	Ord. no.	Price	Pcs.
		I_n max A	Type	Numbers of breakers	Numbers of poles					
600	200	160	Tmax XT1	1	4 + RC sel.	225	CHCA1611	2CPX078255R9999		1
	200	160	Tmax XT2	1	4 + RC sel.	225	CHCB1611	2CPX078256R9999		1
	200	250	Tmax XT3	1	4 + RC sel.	225	CHCC1611	2CPX078257R9999		1
	200	250	Tmax XT4	1	4 + RC sel.	225	CHCD1611	2CPX078258R9999		1
	200	320	Tmax T4	1	4 + RC sel.	225	CHCE1611	2CPX078259R9999		1
	300	630	Tmax T5	1	4 + RC sel.	275	CHCF1611	2CPX078260R9999		1
	800	200	160	Tmax XT1	1	4 + RC sel.	225	CHDA1611	2CPX078261R9999	
200		160	Tmax XT2	1	4 + RC sel.	225	CHDB1611	2CPX078262R9999		1
200		250	Tmax XT3	1	4 + RC sel.	225	CHDC1611	2CPX078263R9999		1
200		250	Tmax XT4	1	4 + RC sel.	225	CHDD1611	2CPX078264R9999		1
200		320	Tmax T4	1	4 + RC sel.	225	CHDE1611	2CPX078265R9999		1
300		630	Tmax T5	1	4 + RC sel.	275	CHDF1611	2CPX078266R9999		1

> Hinge set for covers see page 57

CombiLine S distribution panel system

Moulded case circuit breaker Tmax, vertical

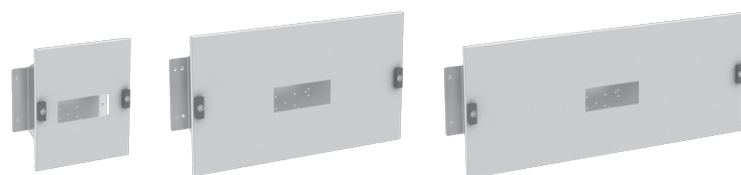

CVAC1511

CVCC1511

DVDC1511

Tmax breaker vertical 3-/4-pole

- Unequipped set for ABB Tmax as an incomer or outgoing breaker
- For fixed version with lever operation and front terminals
- Sheet steel cover with cut-out for 3*-/4-pole breaker
- Cover with 1/4 turn quick-lock

2

Width mm	Height mm	For device				Minimum cabinet depth	Type	Ord. no.	Price	Pcs.
		I_n max A	Type	Numbers of breakers	Numbers of poles					
300	300	160	Tmax XT1	1	3/4	225	CVAA1511	2CPX078267R9999		1
	300	250	Tmax XT2	1	3/4	225	CVAB1511	2CPX078268R9999		1
	300	250	Tmax XT3	1	3/4	225	CVAC1511	2CPX078269R9999		1
	300	250	Tmax XT4	1	3/4	225	CVAD1511	2CPX078270R9999		1
	350	320	Tmax T4	1	3/4	225	CVAH1511	2CPX078271R9999		1
	350	630	Tmax T5	1	3/4	275	CVAH1511	2CPX078271R9999		1
600	300	160	Tmax XT1	1	3/4	225	CVCA1511	2CPX078272R9999		1
	300	160	Tmax XT2	1	3/4	225	CVCB1511	2CPX078273R9999		1
	300	250	Tmax XT3	1	3/4	225	CVCC1511	2CPX078274R9999		1
	300	250	Tmax XT4	1	3/4	225	CVCD1511	2CPX078275R9999		1
	350	320	Tmax T4	1	3/4	225	CVCH1511	2CPX078276R9999		1
	350	630	Tmax T5	1	3/4	275	CVCH1511	2CPX078276R9999		1
	450	800	Tmax T6	1	3/4	275	CVCG1511	2CPX078277R9999		1
800	300	160	Tmax XT1	1	3/4	225	CVDA1511	2CPX078278R9999		1
	300	160	Tmax XT2	1	3/4	225	CVDB1511	2CPX078279R9999		1
	300	250	Tmax XT3	1	3/4	225	CVDC1511	2CPX078280R9999		1
	300	250	Tmax XT4	1	3/4	225	CVDD1511	2CPX078281R9999		1
	350	320	Tmax T4	1	3/4	225	CVDH1511	2CPX078282R9999		1
	350	630	Tmax T5	1	3/4	275	CVDH1511	2CPX078282R9999		1
	450	800	Tmax T6	1	3/4	275	CVDG1511	2CPX078283R9999		1

*For 3 poles breakers please order accessory flange codes: AD3305 XT1 3P Flange for plate-mounting - AD3306 XT2 3P Flange for plate-mounting - AD3307 XT3 3P Flange for plate-mounting - AD3308 XT4 3P Flange for plate-mounting.

> Hinge set for covers see page 57

CombiLine S distribution panel system

Moulded case circuit breaker Tmax, vertical

2

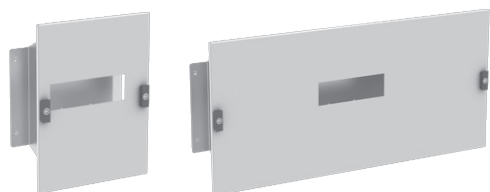

CVAC1611

CVDC1611

Tmax breaker vertical 4-pole + RC sel.

- Unequipped set for ABB Tmax as an incomer or outgoing breaker
- For fixed version with lever operation and front terminals
- Sheet steel cover with cut-out for 4-pole breaker and RC Sel.
- Cover with 1/4 turn quick-lock

Width mm	Height mm	For device				Minimum cabinet depth	Type	Ord. no.	Price	Pcs.
		I_n max A	Type	Numbers of breakers	Numbers of poles					
300	300	160	Tmax XT1	1	4 + RC sel.	225	CVAA1611	2CPX078284R9999		1
	350	250	Tmax XT2	1	4 + RC sel.	225	CVAB1611	2CPX078285R9999		1
	350	250	Tmax XT3	1	4 + RC sel.	225	CVAC1611	2CPX078286R9999		1
	350	250	Tmax XT4	1	4 + RC sel.	225	CVAD1611	2CPX078287R9999		1
	450	320	Tmax T4	1	4 + RC sel.	225	CVAE1611	2CPX078288R9999		1
	450	630	Tmax T5	1	4 + RC sel.	275	CVAF1611	2CPX078289R9999		1
600	300	160	Tmax XT1	1	4 + RC sel.	225	CVCA1611	2CPX078290R9999		1
	350	160	Tmax XT2	1	4 + RC sel.	225	CVCB1611	2CPX078291R9999		1
	350	250	Tmax XT3	1	4 + RC sel.	225	CVCC1611	2CPX078292R9999		1
	350	250	Tmax XT4	1	4 + RC sel.	225	CVCD1611	2CPX078293R9999		1
	450	320	Tmax T4	1	4 + RC sel.	225	CVCE1611	2CPX078294R9999		1
	450	630	Tmax T5	1	4 + RC sel.	275	CVCF1611	2CPX078295R9999		1
800	300	160	Tmax XT1	1	4 + RC sel.	225	CVDA1611	2CPX078296R9999		1
	350	160	Tmax XT2	1	4 + RC sel.	225	CVDB1611	2CPX078297R9999		1
	350	250	Tmax XT3	1	4 + RC sel.	225	CVDC1611	2CPX078298R9999		1
	350	250	Tmax XT4	1	4 + RC sel.	225	CVDD1611	2CPX078299R9999		1
	450	320	Tmax T4	1	4 + RC sel.	225	CVDE1611	2CPX078300R9999		1
	450	630	Tmax T5	1	4 + RC sel.	275	CVDF1611	2CPX078301R9999		1

> Hinge set for covers see page 57

CombiLine S distribution panel system

Moulded case circuit breaker Tmax, vertical



Tmax breaker vertical side-by-side

- Unequipped set for ABB Tmax as an incomer or outgoing breaker
- For fixed version with lever operation and front terminals
- Sheet steel cover with knock-out for 3*-/4-pole breaker side by side
- Cover with 1/4 turn quick-lock

2

Width mm	Height mm	For device				Minimum cabinet depth	Type	Ord. no.	Price	Pcs.
		I_n max A	Type	Numbers of breakers	Numbers of poles					
600	300	250	Tmax XT1	3	3/4	225	CVCA3511	2CPX078398R9999		1
	300	250	Tmax XT2	3	3/4	225	CVCB3511	2CPX078399R9999		1
	300	250	Tmax XT3	3	3/4	225	CVCC3511	2CPX078400R9999		1
	300	250	Tmax XT4	3	3/4	225	CVCD3511	2CPX078401R9999		1
800	300	250	Tmax XT1	4	3/4	225	CVDA4511	2CPX078402R9999		1
	300	250	Tmax XT2	4	3/4	225	CVDB4511	2CPX078403R9999		1
	300	250	Tmax XT3	4	3/4	225	CVDC4511	2CPX078404R9999		1
	300	250	Tmax XT4	4	3/4	225	CVDD4511	2CPX078405R9999		1

*For 3 poles breakers please order accessory flange codes: AD3305 XT1 3P Flange for plate-mounting - AD3306 XT2 3P Flange for plate-mounting - AD3307 XT3 3P Flange for plate-mounting - AD3308 XT4 3P Flange for plate-mounting.

> Hinge set for covers see page 57

CombiLine S distribution panel system

Switch disconnecter OT, horizontal

2



CHCQ1513

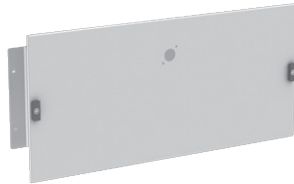

CHDQ1513

OT switch disconnecter horizontal

- Unequipped set for ABB OT...E03/04P as an incomer or outgoing switch
- Sheet steel cover with cut out for rotary handle in top of the center
- Cover fixed with one 1/4 turn quick-lock
- **Important:** in case of using switch disconnectors OT630 and OT800 it is not possible to use busbar system behind the mounting plate

Width mm	Height mm	For device				Minimum cabinet depth	Type	Ord. no.	Price	Pcs.
		I_n max A	Type	Numbers of breakers	Numbers of poles					
600	350	400	OT200, OT250, OT315, OT400	1	3/4	225	CHCQ1513	2CPX078302R9999		1
	500	800	OT630, OT800	1	3/4	275	CHCR1513	2CPX078377R9999		1
800	350	400	OT200, OT250, OT315, OT400	1	3/4	225	CHDQ1513	2CPX078303R9999		1
	500	800	OT630, OT800	1	3/4	275	CHDR1513	2CPX078378R9999		1

> Hinge set for covers see page 57

CombiLine S distribution panel system

Switch disconnecter OT, vertical

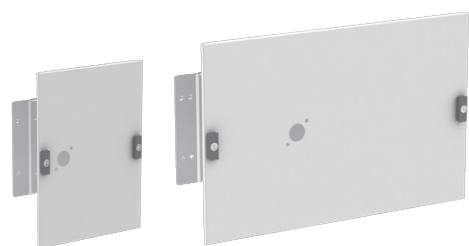

CVAP1513

CVDQ1513

OT switch disconnecter vertical left

- Unequipped set for ABB OT...E03/04P as an incomer or outgoing switch
- Sheet steel cover with cut out for rotary handle on the left side
- Cover fixed with one 1/4 turn quick-lock
- **Important:** in case of using switch disconnectors OT630 and OT800 it is not possible to use busbar system behind the mounting plate

2

Width mm	Height mm	For device				Minimum cabinet depth	Type	Ord. no.	Price	Pcs.
		I_n max A	Type	Numbers of breakers	Numbers of poles					
300	350	250	OT200, OT250	1	3/4	225	CVAP1513	2CPX078304R9999		1
600	350	400	OT200, OT250, OT315, OT400	1	3/4	225	CVCQ1513	2CPX078305R9999		1
			OT630, OT800							
800	350	400	OT200, OT250, OT315, OT400	1	3/4	225	CVDQ1513	2CPX078306R9999		1
			OT630, OT800							

> Hinge set for covers see page 57



CVAP1514

CVDQ1514

OT switch disconnecter vertical center

- Unequipped set for ABB OT...E12/22P as an incomer or outgoing switch vertical
- Sheet steel cover with cut out for rotary handle in the center
- Cover fixed with 1/4 turn quick-lock
- **Important:** in case of using switch disconnectors OT630 and OT800 it is not possible to use busbar system behind the mounting plate

Width mm	Height mm	For device				Minimum cabinet depth	Type	Ord. no.	Price	Pcs.
		I_n max A	Type	Numbers of breakers	Numbers of poles					
300	350	250	OT200, OT250	1	3/4	225	CVAP1514	2CPX078307R9999		1
600	350	400	OT200, OT250, OT315, OT400	1	3/4	225	CVCQ1514	2CPX078308R9999		1
			OT630, OT800							
800	350	400	OT200, OT250, OT315, OT400	1	3/4	225	CVDQ1514	2CPX078309R9999		1
			OT630, OT800							

> Hinge set for covers see page 57

CombiLine S distribution panel system

DIN rail components

2

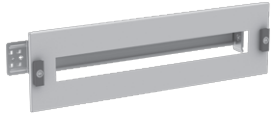

CKDB1615

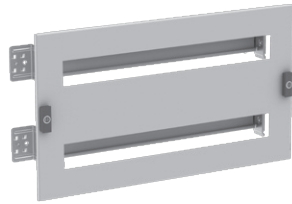

CKDB2630

DIN rail distance 150 mm for S200

- Unequipped set for DIN rail components
- Din rail distance 150 mm
- System Pro M S200, switch OT160 (front level)
- DIN rail is fixed on a mounting bracket
- The material is aluminium
- On the back-side it is possible to use Unifix L
- Cover with 1/4 turn quick-lock

Width mm	Height mm	Additional information				Minimum cabinet depth	Type	Ord. no.	Price	Pcs.
		I_n max A	Space units (SU)	Din rail distance	Numbers of rows					
600	150	160	24	150	1	225	CKDB1615: 2CPX078318R9999		1	
800	150	160	36	150	1	225	CKDB1815: 2CPX078319R9999		1	
600	300	160	48	150	2	225	CKDB2630: 2CPX078406R9999		1	
800	300	160	72	150	2	225	CKDB2830: 2CPX078407R9999		1	

> Unifix L see page 69



CKDC1620

DIN rail distance 200 mm for S200, Tmax

- Unequipped set for DIN rail components
- Din rail distance 200 mm
- System Pro M S200, switch OT160 (front level)
- Tmax, XT1, XT3 breaker 3+4 pole version (back level)
- DIN rail is fixed on a mounting bracket
- The material is aluminium
- On the back-side it is possible to use Unifix L,
- A depth adapter enables the same depth of MCCB and DIN rail components S200
- Cover is with DIN cut-out

Width mm	Height mm	Additional information				Minimum cabinet depth	Type	Ord. no.	Price	Pcs.
		I_n max A	Space units (SU)	Din rail distance	Numbers of rows					
300	200	250	12	200	1	225	CKDC1320: 2CPX078320R9999		1	
600	200	250	24	200	1	225	CKDC1620: 2CPX078321R9999		1	
800	200	250	36	200	1	225	CKDC1820: 2CPX078322R9999		1	

> Unifix L see page 69

CombiLine S distribution panel system

DIN rail components

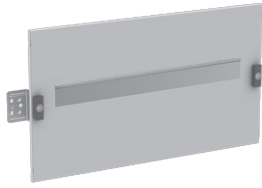

CKDR1630

DIN rail for Tmax 4 pole + RC sel.

- Unequipped set for Tmax breaker, XT1, XT3 4 pole with RC sel.
- DIN rail is fixed on a mounting bracket
- The material is aluminium
- On the back-side it is possible to use Unifix L,
- A depth adapter enables the same depth of MCCB and DIN rail components S200
- Cover is with DIN cut-out
- Cover fixed with 1/4 turn quick-lock

Width mm	Height mm	Additional information				Minimum cabinet depth	Type	Ord. no.	Price	Pcs.
		I _n max A	Space units (SU)	Din rail distance	Numbers of rows					
600	300	250	24	300	1	225	CKDR1630	2CPX078383R9999		1
800	300	250	36	300	1	225	CKDR1830	2CPX078384R9999		1

> Unifix L see page 69

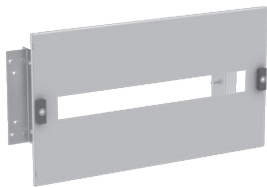

CKDU1630

DIN rail for Unifix H

- Unequipped set for System Unifix H
- The System Unifix H can be fixed on supports
- Cover is with DIN cut-out
- Cover fixed with one 1/4 turn quick-lock

Width mm	Height mm	Additional information				Minimum cabinet depth	Type	Ord. no.	Price	Pcs.
		I _n max A	Space units (SU)	Din rail distance	Numbers of rows					
600	300	250	24	300	1	225	CKDU1630	2CPX078385R9999		1
800	300	250	36	300	1	225	CKDU1830	2CPX078386R9999		1

> Unifix H see page 70

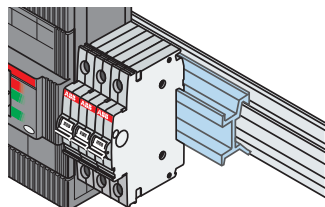

Article	Width in mm	Type	Ord. No.	Price	Pcs.
Depth adapters Enables the depth of miniature circuit-breakers to be adapted to that of moulded-case circuit-breakers mounted on the same DIN rail. Depth adapters for Tmax XT1-XT3	600	AP6000			1

CombiLine S distribution panel system

Covers closed

2



CACP3030

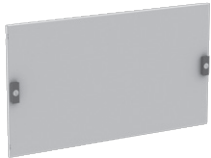

CACP6030

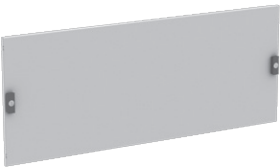

CACP8030



CACP6060

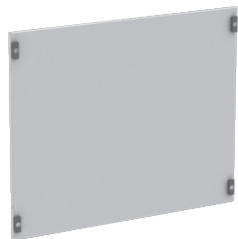

CACP8060

Article	Height in mm	Type	Ord. No.	Price	Pcs.
Cover closed					
Material sheet steel					
With one 1/4 turn quick-lock per side					
Width 300 mm	50	CACP3005	2CPX078340R9999		1
	100	CACP3010	2CPX078341R9999		1
	150	CACP3015	2CPX078342R9999		1
	200	CACP3020	2CPX078343R9999		1
	250	CACP3025	2CPX078344R9999		1
	300	CACP3030	2CPX078345R9999		1
	400	CACP3040	2CPX078346R9999		1
Width 600 mm	50	CACP6005	2CPX078350R9999		1
	100	CACP6010	2CPX078351R9999		1
	150	CACP6015	2CPX078352R9999		1
	200	CACP6020	2CPX078353R9999		1
	250	CACP6025	2CPX078354R9999		1
	300	CACP6030	2CPX078355R9999		1
	400	CACP6040	2CPX078356R9999		1
Width 800 mm	50	CACP8005	2CPX078360R9999		1
	100	CACP8010	2CPX078361R9999		1
	150	CACP8015	2CPX078362R9999		1
	200	CACP8020	2CPX078363R9999		1
	250	CACP8025	2CPX078364R9999		1
	300	CACP8030	2CPX078365R9999		1
	400	CACP8040	2CPX078366R9999		1
Cover closed					
Material sheet steel					
With two 1/4 turn quick-lock per side					
Width 300 mm	500	CACP3050	2CPX078347R9999		1
	600	CACP3060	2CPX078348R9999		1
	800	CACP3080	2CPX078349R9999		1
Width 600 mm	500	CACP6050	2CPX078357R9999		1
	600	CACP6060	2CPX078358R9999		1
	800	CACP6080	2CPX078359R9999		1
Width 800 mm	500	CACP8050	2CPX078367R9999		1
	600	CACP8060	2CPX078368R9999		1
	800	CACP8080	2CPX078369R9999		1

CombiLine S distribution panel system

Covers for measuring instruments



CKUA6020



CKUB6020

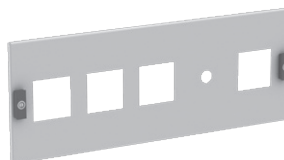

CKUC6020

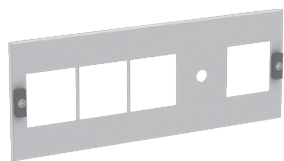

CKUD6020



CAEC6



CAHCP10

Article	Width in mm	Type	Ord. No.	Price	Pcs.
Covers for universal measuring instruments					
For 2 measuring instrument 72 x 72 mm Cover fixed with one 1/4 turn screws on every side Material sheet steel Height 200 mm	600	CKUA6020	2CPX078310R9999		1
	800	CKUA8020	2CPX078311R9999		1
For 2 measuring instrument 96 x 96 mm Cover fixed with one 1/4 turn screws on every side Material sheet steel Height 200 mm	600	CKUB6020	2CPX078312R9999		1
	800	CKUB8020	2CPX078313R9999		1
For 4 universal measuring instruments 72 x 72 mm Cover fixed with one 1/4 turn screws on every side Material sheet steel Height 200 mm	600	CKUC6020	2CPX078314R9999		1
	800	CKUC8020	2CPX078315R9999		1
For 4 universal measuring instruments 96 x 96 mm Cover fixed with one 1/4 turn screws on every side Material sheet steel Height 200 mm	600	CKUD6020	2CPX078316R9999		1
	800	CKUD8020	2CPX078317R9999		1
Earthing set		CAEC6	2CPX078462R9999		1
Connection between cover and structure, when using devices in the cover Cable diameter 6 mm ²					
Hinge set for covers		CAHCP10	2CPX078485R9999		1
Opening angle 90° Per cover are 2 pcs. required					

CombiLine S distribution panel system

Mounting plates

2

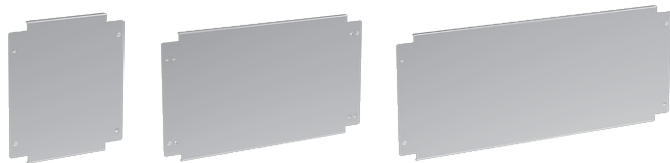

CAMF3030

CAMF6030

CAMF8030

- Mounting plate is for fixed mounted on profile
- Distance between mounting plate and cover is 110 mm
- Material sheet steel

Width mm	Height mm	Usable space		Minimum cabinet depth	Type	Ord. no.	Price	Pcs.
		Height mm	Width mm					
300	300	295	216	225	CAMF3030	2CPX078323R9999		1
600	150	145	432	225	CAMF6015	2CPX078324R9999		1
	200	195	432	225	CAMF6020	2CPX078325R9999		1
	250	245	432	225	CAMF6025	2CPX078326R9999		1
	300	295	432	225	CAMF6030	2CPX078327R9999		1
	400	395	432	225	CAMF6040	2CPX078328R9999		1
	500	495	432	225	CAMF6050	2CPX078329R9999		1
	600	595	432	225	CAMF6060	2CPX078330R9999		1
	800	795	432	225	CAMF6080	2CPX078331R9999		1
800	150	145	648	225	CAMF8015	2CPX078332R9999		1
	200	195	648	225	CAMF8020	2CPX078333R9999		1
	250	245	648	225	CAMF8025	2CPX078334R9999		1
	300	295	648	225	CAMF8030	2CPX078335R9999		1
	400	395	648	225	CAMF8040	2CPX078336R9999		1
	500	495	648	225	CAMF8050	2CPX078337R9999		1
	600	595	648	225	CAMF8060	2CPX078338R9999		1
	800	795	648	225	CAMF8080	2CPX078339R9999		1

CombiLine S distribution panel system

Internal form of separation Form 2b



CKFH1620

- Set to separate the busbar behind device area
- Touch protection in front of the busbar system
- Mounting position horizontal
- Material is transparent plastic

Width mm	Height mm	Type	Ord. no.	Price	Pcs.
600	200	CKFH1620	2CPX078463R9999		1
800	200	CKFH1820	2CPX078464R9999		1



CKFH2620

- Set to separate the busbar behind device area
- Touch protection in front of the busbar system and in addition top or bottom
- Mounting position horizontal
- Material is transparent plastic

Width mm	Height mm	Type	Ord. no.	Price	Pcs.
600	200	CKFH2620	2CPX078465R9999		1
800	200	CKFH2820	2CPX078466R9999		1



CKFH3620

- Set to separate the busbar behind device area
- Touch protection behind the busbar system
- Mounting position horizontal
- Material is transparent plastic

Width mm	Height mm	Type	Ord. no.	Price	Pcs.
600	200	CKFH3620	2CPX078467R9999		1
800	200	CKFH3820	2CPX078468R9999		1



CKFV8060

Article	Height in mm	Type	Ord. no.	Price	Pcs.	
Set to separate the busbars in external cable container to the device area	600	CKFV8060	2CPX078469R9999		1	
	800	CKFV8080	2CPX078470R9999		1	
	1000	CKFV8100	2CPX078471R9999		1	
	1200	CKFV8120	2CPX078472R9999		1	
	1400	CKFV8140	2CPX078473R9999		1	
	1600	CKFV8160	2CPX078474R9999		1	
	1800	CKFV8180	2CPX078475R9999		1	
	2000	CKFV8200	2CPX078476R9999		1	
	Depth 275 mm	600	CKFV9060	2CPX078477R9999		1
		800	CKFV9080	2CPX078478R9999		1
		1000	CKFV9100	2CPX078479R9999		1
		1200	CKFV9120	2CPX078480R9999		1
		1400	CKFV9140	2CPX078481R9999		1
		1600	CKFV9160	2CPX078482R9999		1
	1800	CKFV9180	2CPX078483R9999		1	
	2000	CKFV9200	2CPX078484R9999		1	

CombiLine S distribution panel system

Busbar system

2

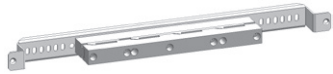

CKBS1161



CKBS1231



CKBS2161



CKBS2231

Article	Width in mm	Min. cabinet depth mm	Type	Ord. No.	Price	Pcs.
Busbar support linear for flat busbars	600	275	CKBS1161	2CPX078447R9999		1
Behind the device area	800	275	CKBS1181	2CPX078448R9999		1
Rated (I_n) max. 630 A Rated peak withstand current (I_{pk}) up to 67 kA Rated short-time withstand current (I_{cw}) 1.0 sec. up to 32 kA To find the right numbers of supports to achieve the short-circuit see the table below, numbers of support 1						
Busbar support scaled for flat busbars	300	225	CKBS1231	2CPX078449R9999		1
For external cable container Rated current (I_n) max. 630 A Rated peak withstand current (I_{pk}) up to 48 kA Rated short-time withstand current (I_{cw}) 1.0 sec. up to 23 kA To find the right numbers of supports to achieve the short-circuit see the table below, numbers of support 1						
Busbar support linear for shaped busbars	600	275	CKBS2161	2CPX078370R9999		1
Behind the device area	800	275	CKBS2181	2CPX078371R9999		1
Rated current (I_n) max. 800 A Rated peak withstand current (I_{pk}) up to 48 kA Rated short-time withstand current (I_{cw}) 1.0 sec. up to 23 kA To find the right numbers of supports to achieve the short-circuit see the table below, numbers of support 1						
Busbar support scaled for shaped busbars	200/300	225	CKBS2231	2CPX078372R9999		1
For internal or external cable container Rated current (I_n) max. 800 A Rated peak withstand current (I_{pk}) up to 63 kA Rated short-time withstand current (I_{cw}) 1.0 sec. up to 30 kA To find the right numbers of supports to achieve the short-circuit see the table below, numbers of support 1						

Table for rated peak withstand current I_{pk} / rated short-time withstand current I_{cw} (1 sec.)

Busbar Type	I_n in A	Busbar support	No. of busbars per phase	17kA / 10kA		40kA / 20kA		48kA / 23kA		67kA / 32kA	
				No. support H = 1750 mm	Max. X (mm)	No. support H = 1750 mm	Max. X (mm)	No. support H = 1750 mm	Max. X (mm)	No. support H = 1750 mm	Max. X (mm)
Busbar support linear for flat busbar											
BR0250	250	CKBS1161	1	4	500	-	-	-	-	-	-
BR0400	400	CKBS1181	1	4	500	6	350	6	350	-	-
BR0630	630	CKBS1181	1	4	600	4	600	4	600	9	250
Busbar support scaled for flat busbars											
BR0250	250	CKBS1231	1	8	275	-	-	-	-	-	-
BR0400	400	CKBS1231	1	8	275	15	125	18	100	-	-
BR0630	630	CKBS1231	1	8	275	15	125	18	100	-	-
Busbar support linear for shaped busbars											
BA0400	400	CKBS2161	1	5	425	5	425	5	425	-	-
BA0800	800	CKBS2181	1	4	550	4	550	4	550	-	-
Busbar support scaled for shaped busbars											
BA0400	400	CKBS2231	1	5	425	5	425	5	425	-	-
BA0800	800	CKBS2231	1	5	425	5	425	5	425	4	550

Max X = maximum distance not to be exceeded between two consecutive busbar holders

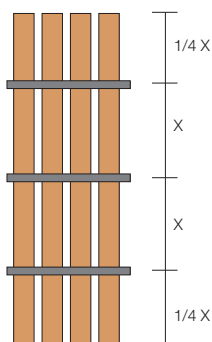

The distance between the first busbar holder and the end of the busbar must not exceed 1/4 of "X".

CombiLine S distribution panel system

Busbar system

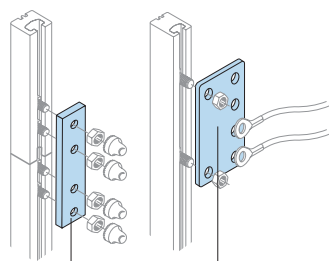

AD1068

AD1077

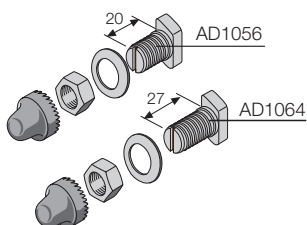

AD1056

AD1064

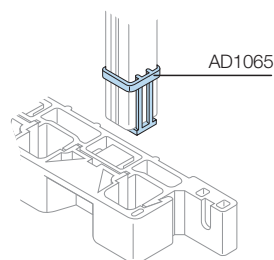

AD1065

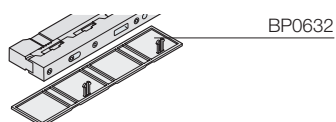

BP0632

Article	Type	Ord. no.	Price	Pcs.
Joints for busbars with shaped section				
No. 4 copper 400 A branch joints	AD1077			4
No. 4 joints for joining busbars with shaped section 400 / 800 A	AD1068			4
Hammer seal screws for busbars with shaped section				
No. 12 M8 screws L = 20 mm for flexible busbars and cable shoes complete with screw-covering cap	AD1056			12
No. 12 M8 screws L = 27 mm for flat busbars 10 mm complete with screw-covering cap	AD1064			12
Resting bases for busbars with shaped section				
No. 4 resting bases for 400 / 800 A busbars	AD1065			4
Busbars holders end cover				
No. 2 terminal covers for linear busbar holders CKBS1161, CKBS1181	BP0632			1

CombiLine S distribution panel system

Busbar system

2

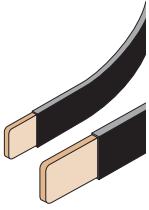

BF1602

Article	Dimensions Length mm	I_n A	Type	Ord. no.	Price	Pcs.
Flexible Busbars						
Flexible busbars insulated with self-extinguishing material						
No. 2 flexible busbars, section 20 x 3	2000	250	BF1602			2
No. 2 flexible busbars, section 20 x 5	2000	400	BF2502			2
No. 2 flexible busbars, section 24 x 6	2000	500	BF4002			2
No. 2 flexible busbars, section 32 x 5	2000	630	BF4012			2

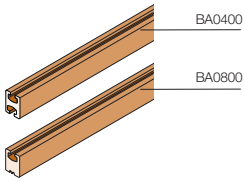

Distribution busbars with shaped section						
Busbar $I_n = 400$ A	1730	400	BA0400			1
Busbar $I_n = 800$ A	1730	800	BA0800			1

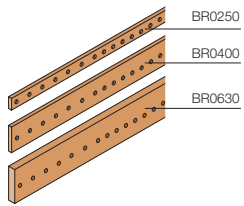

Flat busbar						
Copper busbars drilled and threaded for rapid connection of the conductors						
Can be used with both linear CKBS1161, CKBS1181 and scaled CKBS1231 busbar holder						
No. 2 copper busbar 15 x 5	1750	250	BR0250			2
No. 2 copper busbar 25 x 5	1750	400	BR0400			2
No. 2 copper busbar 30 x 10	1750	630	BR0630			2

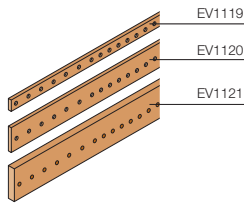

Earthing busbars*						
Busbar can be mounted directly on the mounting profile or busbar 20 x 5 mm on the support for horizontal installation;						
Copper busbars drilled and threaded for rapid connection of the conductors						
No. 2 earthing busbars 20 x 5 threaded M6	2000		EV1119			2
No. 2 earthing busbars 25 x 5 threaded M6	2000		EV1120			2
No. 2 earthing busbars 50 x 5 threaded M6	2000		EV1121			2



Support universal, for horizontal installation			CASHP2	2CPX078450R9999		2
For a Din rail or cable fastening rail or earth busbar max. 20 x 5 mm			CASHP50	2CPX078451R9999		50
For fix mounting						
Material is metal						

* Busbar dimensions can be selected according to IEC 61439-1 table 5

CombiLine S distribution panel system

Busbar system

Cross section	Code	I_n in A	No. busbar/ phase	Dimensions				
				Cu busbar in mm	Section dimensions mm ²	Length mm	Weight kg	
Flexible busbars up to 630 A								
	BF1602	250	1	20 x 3	60	2000	1.42	
	BF2502	400	1	20 x 5	100	2000	2.15	
	BF4002	500	1	24 x 6	144	2000	3	
	BF4012	630	1	32 x 5	160	2000	3.36	

Busbars with shaped section for applications up to 800 A								
	BA0400	400	1	20 x 20	200	1730	4	
	BA0800	800	1	20 x 20	280	1730	4,4	

Cross section	Code	I_n in A	No. busbar/ phase	Dimensions				
				Cu busbar in mm	Section dimensions mm ²	Length mm	Weight kg	
Flat busbars for distribution up to 630 A								
	BR0250	250	1	15 x 5	75	1750	1.35	
	BR0400	400	1	25 x 5	125	1750	1.8	
	BR0630	630	1	30 x 10	300	1750	4.4	

Cross section	Code	Threading	pitch	Dimensions			
				Cu busbar in mm	Section dimensions mm ²	Length mm	
Flat drilled and threaded busbars for earthing connections*							
	EV1119	6 MA	20	20 x 5	100	2000	
	EV1120	6 MA	20	25 x 5	125	2000	
	EV1121	6 MA	25	50 x 5	250	2000	

* Busbar dimensions can be selected according to IEC 61439-1 table 5

CombiLine S distribution panel system

Accessories, mounting support

2



CASHP2



CASVP2

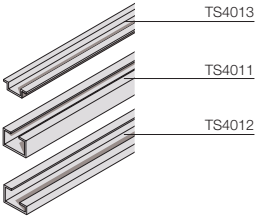

CAHB16

Article	Width mm	Type	Ord. no.	Price	Pcs.
Support universal, for horizontal installation					
For a Din rail or cable fastening rail or earth busbar max. 20 x 5 mm Material is metal		CASHP2	2CPX078450R9999		2
		CASHP50	2CPX078451R9999		50
Support universal, for vertical installation					
For a Din rail or cable fastening Material is metal		CASVP2	2CPX078452R9999		2
		CASVP50	2CPX078453R9999		50
Section for accessories					
Length 2000 mm					
No. 2 sections EN50024 C30		TS4011			2
No. 2 sections EN50035 G32		TS4012			2
No. 2 DIN sections EN50022		TS4013			2
Horizontal mounting profile for busbar support and cable fixing					
Mounted on the back level of the vertical mounting profile Material metal	300	CAHB3	2CPX078456R9999		1
	600	CAHB6	2CPX078457R9999		1
	800	CAHB8	2CPX078458R9999		1

CombiLine S distribution panel system

Accessories, wiring system



CASWP2



CAHW6



ED44P10



ED45P10

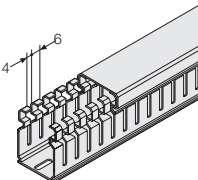
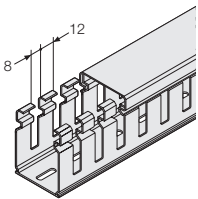

Article	Width mm	Type	Ord. no.	Price	Pcs.
Support for wiring duct					
For wiring ducts with 60 mm and 80 mm height					
Material is Polyamid (PA)					
		CASWP2	2CPX078454R9999		2
		CASWP50	2CPX078455R9999		50
Horizontal mounting profile for Wiring system					
Mounted on support for wiring duct					
Material metal					
	600	CAHW6	2CPX078459R9999		1
	800	CAHW8	2CPX078461R9999		1
Wire holder					
For horizontal mounting profile					
Depth 28.5 mm					
		ED44P10	2CPX062335R9999		10
		ED44P50	2CPX062308R9999		50
		ED44P1000	2CPX062703R9999		1000
Depth 55 mm					
		ED45P10	2CPX062336R9999		10
		ED45P50	2CPX062310R9999		50
		ED45P1000	2CPX062704R9999		1000
Wiring ducts					
For horizontal and vertical installation					
RAL 7035, lenght 2000 mm					
Slot 8 - 12 mm					
Base x Height in mm					
	60 x 60		05 067		1
	60 x 80		05 087		1
	80 x 60		05 069		1
	80 x 80		05 089		1
Slot 4 - 6 mm					
Base x Height in mm					
	60 x 60		05 167		1
	60 x 80		05 187		1
	80 x 60		05 169		1
	80 x 80		05 189		1

CombiLine S distribution panel system

Distribution system, modular dividers

2

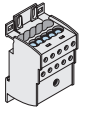

AD1080



AD1081



AD1030
AD1031

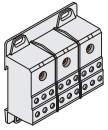

AD1075
AD1006

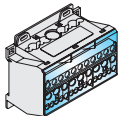

AD1004

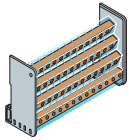

AD1028
AD1029

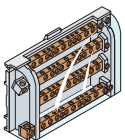





AD1027

Article	Type	Ord. no.	Price	Pcs.
Single-pole				
Modular 125 A	Ⓛ	AD1076		1
Modular 125 A	Ⓛ	AD1080		1
Modular 175 A	Ⓛ	AD1007		1
Modular 175 A	Ⓛ	AD1081		1
Modular 250 A	Ⓛ	AD1030		1
Modular 400 A	Ⓛ	AD1031		1
Three-pole				
Modular 125 A	Ⓛ	AD1075		1
Modular 175 A	Ⓛ	AD1006		1
Four-pole				
Modular 125 A		AD1004		1
Modular 125 A - medium - 93 x 89 x 48 (H x L x P)		AD1028		1
Modular 125 A - large - 96 x 126 x 48 (H x L x P)		AD1029		1
Modular 160 A		AD1027		1
Amounting accessories				
Connection accessory between two AD 1080		AD1083		1

CombiLine S distribution panel system

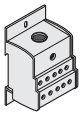
Distribution system, modular dividers

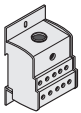
2

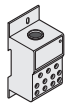
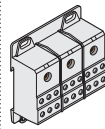
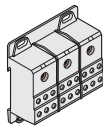
		Single-pole						Three-poles	
									
Code		AD1076	AD1080(1)	AD1007	D1081(2)	AD1030	AD1031	AD1075	AD1006
I_n	(A)	125	125	175	175	250	400	125	175
I_{cw}	(kA)	4.4	4.2	11	1.1	21	21	4.4	11
Version	pole	1	1	1	1	1	1	3	3
Installation		DIN35/plate	DIN35/plate	DIN35/plate	DIN35/plate	DIN35/plate	DIN35/plate	DIN35/plate	DIN35/plate
Power supply \emptyset cable (mm ²)	min.	10	6	16	10	35	95	10	16
	max.	35	35	70	70	120	185	35	70
No. outgoing feeder \emptyset cable (mm ²)	1,5÷10					4	4		
	2,5÷16	10	6	10	6	5	5	6	6
	2,5÷25					2	2		
Dimensions H x W x D	(mm)	71 x 45 x 42,5	74 x 27 x 47	71 x 45 x 42,5	92 x 35 x 49	95.5 x 45 x 49	95.5 x 45 x 49	71.5 x 80 x 42,5	71.5 x 80 x 42,5
No. DIN modules		2,5	1,5	2,5	2	3	3	4,5	4,5
Rated service voltage U_e	(V)	1000 V _{ac}	1000 V _{ac}	1000 V _{ac}	1000 V _{ac}	1000 V _{ac}	1000 V _{ac}	1000 V _{ac}	1000 V _{ac}
		1500 V _{dc}	1500 V _{dc}	1500 V _{dc}	1500 V _{dc}	1500 V _{dc}	1500 V _{dc}	1500 V _{dc}	1500 V _{dc}
Degree of protection	IP	20	20	20	20	20	20	20	20

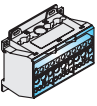
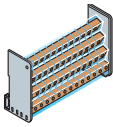
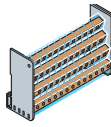
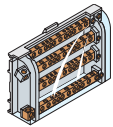
		Four poles			
					
Code		AD1004	AD1028	AD1029	AD1027
I_n	(A)	125	125	125	160
I_{cw}	(kA)	10	4.2	4.2	6.2
I_{pk}	(kA)	24	25	25	20
Version	poli	4.2	4	4	4
Installation		DIN35/plate	DIN35/plate	DIN35/plate	DIN35
Power supply \emptyset cable (mm ²)	min.	6	6	6	10
	max.	35	25 with cable terminal	25 with cable terminal	50
No. outgoing feeder \emptyset cable (mm ²)	1/6	5/phase			
	1.5/6	4/neutral			
	1.5/10	2/phase	7	9	
		6/neutral			
	1.5/16			2	
	2.5/16				8
6/25		2	2	3	
Dimensions H x W x D	(mm)	74.5 x 98 x 45	93 x 89 x 48	96 x 126 x 48	90 x 160.5 x 50
No. DIN modules		5,5	5	7	9
Rated service voltage U_e	(V)	1000 V _{ac}	440	440	440
		1500 V _{dc}			
Degree of protection	IP	20	20	20	20

⁽¹⁾ Possibility of putting in parallel with AD1083 connections

⁽²⁾ Possibility of putting in parallel with comb type connection (not supplied)

CombiLine S distribution panel system

Distribution system Unifix, overview

2

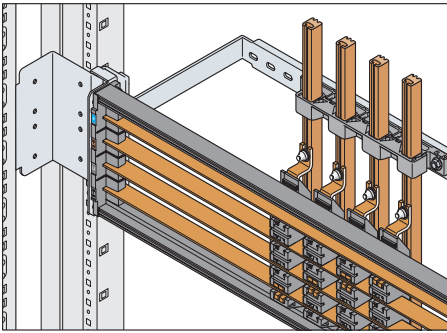

Direct connection with the 400/800 A system of busbars with shaped section.

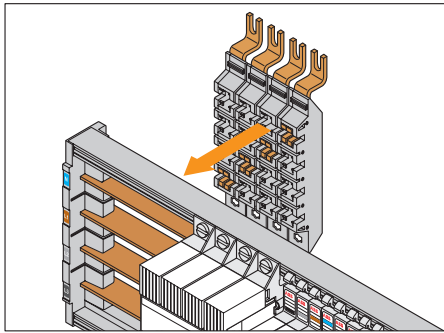

Feeder module for 400 A frame (L1-L2-L3-N).

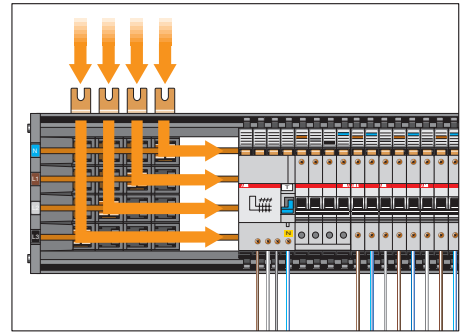

Direct power supply of the bases by means of feeder module ED2209.

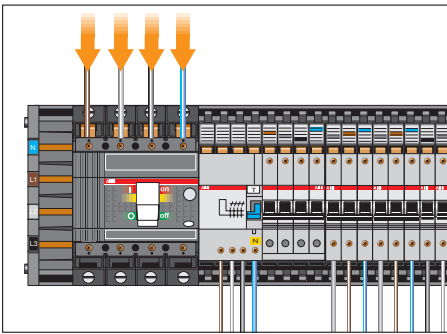

Power supply by means of general row circuit-breaker.

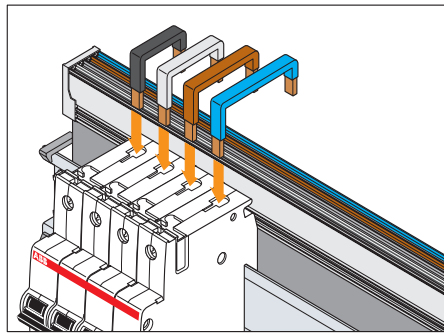

Connections (L1-L2-L3-N) for System Pro M modular apparatus.

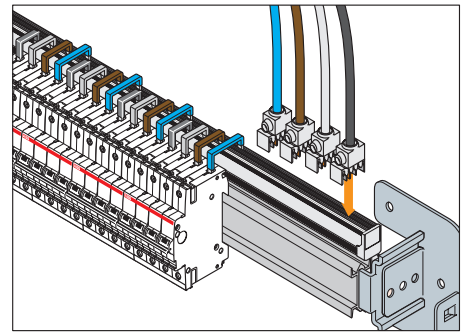

Power supply of the busbar with 100 A feeder module without cable. Terminal capacity 35mm².

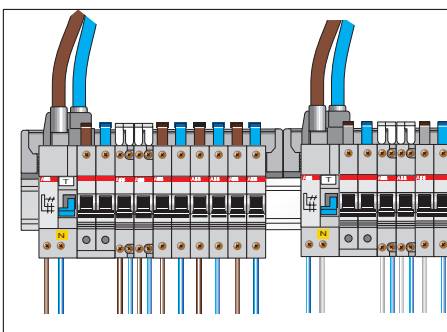

Direct power supply of the busbars by means of feeder module.

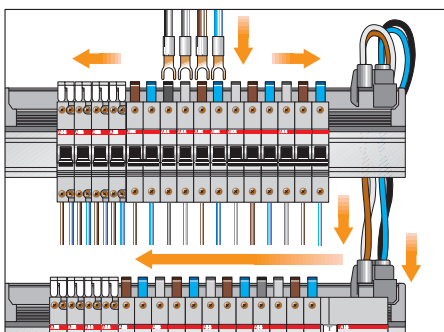

Power supply by means of modules and cables in parallel.

CombiLine S distribution panel system

Distribution system Unifix L

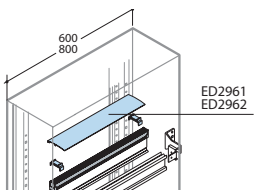
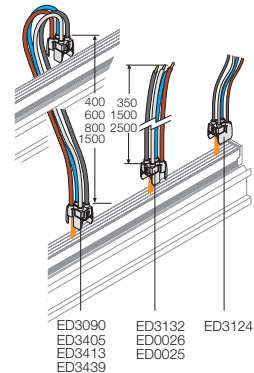
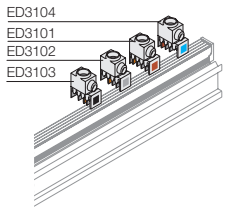
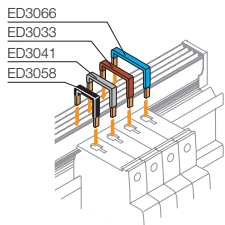
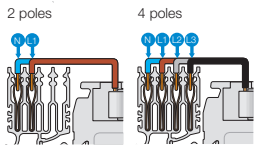

Article	Type	Ord. no.	Price	Pcs.
2-pole busbars				
100 A 2P 8 module busbar, width 200 mm	ED2985			6
100 A 2P 12 module busbar, width 400 mm	ED2993			6
100 A 2P 18 module busbar, width 450 mm	ED3009			6
100 A 2P 24 module busbar, width 600 mm	ED3017			6
100 A 2P 36 module busbar, width 800 mm	ED3025			6
4-pole busbars				
100 A 4P 12 module busbar, width 400 mm	ED2944			6
100 A 4P 18 module busbar, width 450 mm	ED2951			6
100 A 4P 24 module busbar, width 600 mm	ED2969			6
100 A 4P 36 module busbar, width 800 mm	ED2977			6
Connections for various apparatus				
Connection with 2 conductors L/N 16 A	ED3108			6
Connection with 3 conductors L1/L2/L3 16 A	ED3116			6
Connection with 4 conductors L1/L2/L3/N 16 A single phase	ED3124			6
Connection with 2 conductors L1/N 40 A	ED3355			6
Connection with 3 conductors L1/L2/L3 40 A	ED3363			6
Connection with 4 conductors L1/L2/L3/N 40 A	ED3371			6
Connections for apparatus				
No. 10 connections L1-N 40 A	ED3272			10
No. 10 connections L2-N 40 A	ED3280			10
No. 10 connections L3-N 40 A	ED3298			10
No. 10 connections L 1 100 A	ED3033			10
No. 10 connections L 2 100 A	ED3041			10
No. 10 connections L 3 100 A	ED3058			10
No. 10 connections N 100 A	ED3066			10
Feeder with 4P 100 A cable, width 350 mm	ED3132			10
Feeder with 4P 100 A cable, width 1500 mm	ED0026			10
Feeder with 4P 100 A cable, width 1500 mm	ED0025			10
Power supply modules with cable				
Parallel module 2P 100 A with cable, width 600 mm	ED3082			6
Parallel module 4P 100 A with cable, width 400 mm	ED3405			6
Parallel module 4P 100 A with cable, width 600 mm	ED3090			6
Parallel module 4P 100 A with cable, width 800 mm	ED3413			6
Parallel module 4P 100 A with cable, width 1500 mm	ED3439			6
Power supply modules without cable I_n 100 A				
No. 10 single-pole power supply terminals L1	ED3101			10
No. 10 single-pole power supply terminals L2	ED3102			10
No. 10 single-pole power supply terminals L3	ED3103			10
No. 10 single-pole power supply terminals N	ED3104			10
Accessories				
N°10 busbar covers, width 600 mm	ED2961			10
N°2 busbar covers, width 800 mm	ED2962			2

CombiLine S distribution panel system

Distribution system Unifix H

2

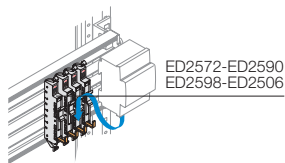
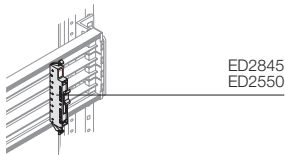
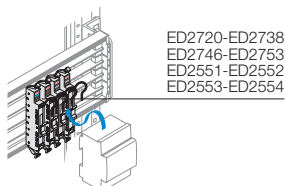
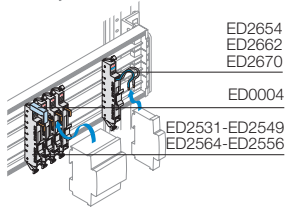
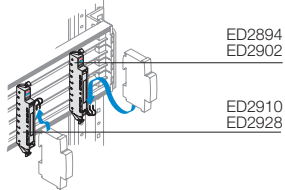
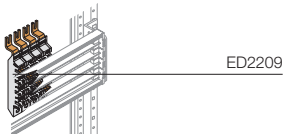
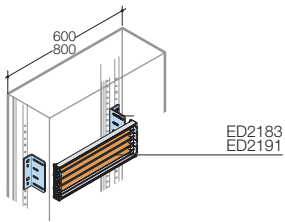

Article	Type	Ord. no.	Price	Pcs.
Frames for Tmax				
Frame with 24 DIN module busbar	ED2183			1
Frame with 36 DIN module busbar	ED2191			1
Feeder modules				
4P 400 A feeder module (for ED2183-ED2191)	ED2209			1
Basic modules I_n 16 A				
Basic module for DIN L1-N top 16 A	ED2894			1
Basic module for DIN L1-L2 top 16 A	ED2902			1
Basic module for DIN L1-N bottom 16 A	ED2910			1
Basic module for DIN L1-L2 bottom 16 A	ED2928			1
Basic modules I_n 40 A				
Basic module L1/Neutral top 40 A	ED2654			1
Basic module L2/Neutral top 40 A	ED2662			1
Basic module L3/Neutral top 40 A	ED2670			1
Basic modules I_n 63 A				
Basic module L1 top 63 A	ED2531			1
Basic module L2 top 63 A	ED2549			1
Basic module L3 top 63 A	ED2556			1
Basic module Neutral top 63 A	ED2564			1
Basic module L1 bottom 63 A	ED2572			1
Basic module L2 bottom 63 A	ED2590			1
Basic module L3 bottom 63 A	ED2598			1
Basic module Neutral bottom 63 A	ED2606			1
Basic modules I_n 100 A				
Basic module with cable L1 top 100 A	ED2720			10
Basic module with cable L2 top 100 A	ED2738			2
Basic module with cable L3 top 100 A	ED2746			1
Basic module with cable Neutral top 100 A	ED2753			1
Basic modules ≤ I_n 40 A S800				
Basic module L1 top ≤ 40 A	ED2557			1
Basic module L2 top ≤ 40 A	ED2558			1
Basic module L3 top ≤ 40 A	ED2559			1
Basic module Neutral top ≤ 40 A	ED2560			1
Basic modules ≤ I_n 125 A S800				
Basic module L1 top 125 A	ED2551			1
Basic module L2 top 125 A	ED2552			1
Basic module L3 top 125 A	ED2553			1
Basic module Neutral bottom 125 A	ED2554			1
Basic module false pole, width 27 mm	ED2557			1

CombiLine S distribution panel system

Distribution system Unifix H

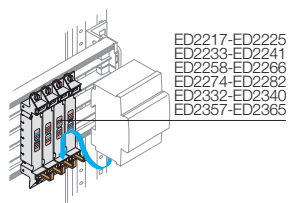

ED2217-ED2225
ED2233-ED2241
ED2258-ED2266
ED2274-ED2282
ED2332-ED2340
ED2357-ED2365

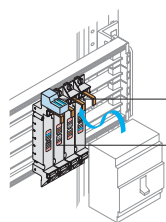

ED0001
ED0002
ED0003
ED2290-ED2308
ED2316-ED2324

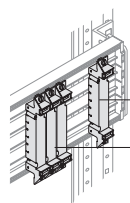

ED2373
ED2381
ED2399

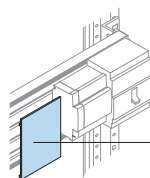

ED2407

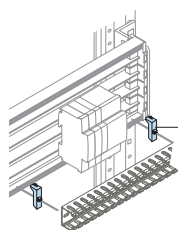

ED2936

Article	Type	Ord. no.	Price	Pcs.
Basic modules ≤ I_n 160 A, Tmax XT1				
Basic module L1 top L2 bottom	ED2217			1
Basic module L2 top L1 bottom	ED2225			1
Basic module L3 top Neutral bottom	ED2233			1
Basic module Neutral top L3 bottom	ED2241			1
Basic module false pole for residual current release RC221	ED2373			1
Basic module false pole for solenoid operator	ED2381			1
Basic modules ≤ I_n 250 A, Tmax XT3				
Basic module L1 top	ED2290			1
Basic module L2 top	ED2308			1
Basic module L3 top	ED2316			1
Basic module N top	ED2324			1
Basic module L1 bottom	ED2332			1
Basic module L2 bottom	ED2340			1
Basic module L3 bottom	ED2357			1
Basic module N bottom	ED2365			1
Basic module false pole for residual current release RC221	ED2373			1
Accessories				
Basic module false pole for DDA	ED2845			1
Basic module false pole for modular MDRC	ED2852			1
No. 2 IP20 covers (for ED2183-ED2191), width 173 mm (10 DIN modules)	ED2407			2
No. 6 duct supports 40 x 60 mm (only for modular apparatus)	ED2936			6
Spare parts				
No. 10 terminal covers for Tmax XT1	ED0001			10
No. 10 terminal covers for Tmax XT3	ED0003			10
No. 10 terminal covers for S200/F200	ED0004			10

CombiLine S distribution panel system

Distribution system Unifix, technical data

Technical characteristics	Unifix H	Unifix L
Unifix systems		
Rated service voltage (U _n)	690 V AC	400 V AC
Rated insulation voltage (U _i)	1000 V AC	500 V AC
Rated impulse withstand voltage (U _{imp})	8 kV	6 kV
Rated frequency	50/60 Hz	50/60 Hz
Rated current (I _n)		
central power supply	400 A	100 A
lateral power supply	320 A	80 A
Rated short-time withstand current (I _{sw})	25 kA	-
Maximum peak current (I _{pw})	52,5 kA - 400 V	-
Maximum installable circuit-breaker size	250 A	100 A
Conditioned short-circuit current (I _{cc})		
Tmax XT1	50 kA - 400 V	-
Tmax XT3	50 kA - 400 V	-
With circuit-breaker		
S200	-	6 kA - 400 V
S200M	-	10 kA - 400 V
S200P	-	25 kA - 400 V
Degree of protection	IP20 with accessory	IP20
Characteristics of the insulating material	Self-extinguishing thermoplastic V1 (UL94)	Self-extinguishing thermoplastic V1 (UL94)
Characteristics of the conductor material	Electrolytic copper	Electrolytic copper
Width	24/600	12/400
(No. modules/mm)	36/800	24/600
		36/800
Installation of Unifix system		
Frame for Tmax XT series		
300 x 600 mm (H x L)	ED2183	-
300 x 800 mm (H x L)	ED2191	-
Fixing brackets Height 300 mm	AD1097	-
Crosspiece for direct connection to the rear busbars with shaped section with PB0803	TL1000	-
Width 600 mm	TL1100	-
Width 800 mm		
Busbar 4P		
12 mod.	-	ED2993
18 mod.	-	ED3009
24 mod.	-	ED3017
36 mod.	-	ED3025
Busbar 4P		
12 mod.	-	ED2944
18 mod.	-	ED2951
24 mod.	-	ED2969
36 mod.	-	ED2977
Fixing support		
24 mod.	-	GD1520
36 mod.	-	GD1530

⁽¹⁾ Select circuit-breakers in version with front terminals for copper cables.

CombiLine S distribution panel system

Distribution system Unifix, selecting table

Series of circuit-breakers	Unifix H		Unifix L
Unifix systems			
Table for selecting connections according to the circuit-breaker			
SN201	(top power supply)		
DS941	ED2654 L1/N 40 A	-	ED3272 L1/N 40 A
	ED2662 L2/N 40 A	-	ED3280 L2/N 40 A
	ED2670 L3/N 40 A	-	ED3298 L3/N 40 A
S200 - DS200	(top power supply)	(bottom power supply)	
F200 up to 63A (Unifix L)	ED2531 L1 63A	ED2572 L1 63A	ED3033 L1 100A
	ED2549 L2 63A	ED2590 L2 63A	ED3041 L2 100A
	ED2556 L3 63A	ED2598 L3 63A	ED3058 L3 100A
	ED2564 N 63A	ED2606 N 63A	ED3066 N 100A
	ED2845 False pole module	-	-
S800	(top power supply)		
	ED2557 L1 ≤32A	-	-
	ED2558 L2 ≤32A	-	-
	ED2559 L3 ≤32A	-	-
	ED2560 N ≤32A	-	-
	ED2551 L1 125A	-	-
	ED2552 L2 125A	-	-
	ED2553 L3 125A	-	-
	ED2554 N 125A	-	-
	ED2550 False pole module	-	-
S280 (80-100A)	(top power supply)		
E200 up to 100A - RS370 - F200 80/100A (Unifix H)	ED2720 L1 100A	-	ED3132 pow. supply L1/L2/L3/N - 350mm
	ED2738 L2 100A	-	ED0026 pow. supply L1/L2/L3/N - 1500mm
	ED2746 L3 100A	-	ED0025 pow. supply L1/L2/L3/N - 2500mm
	ED2753 N 100A	-	-
MDRC - Various apparatus	(top power supply)	(bottom power supply)	
	ED2894 L1/N 16A	ED2910 L1/N 16A	ED3108 pow. supply 2 cables L1/N 16A
	ED2902 L1/L2 16A	ED2928 L1/L2 16A	ED3116 pow. supply 3 cables L1/L2/L3 16A
	-	-	ED3124 pow. supply 4 cables L1/L2/L3/N 16A
	-	-	ED3355 pow. supply 2 cables L1/N 40A
	-	-	ED3363 pow. supply 3 cables L1/L2/L3 40A
	-	-	ED3371 pow. supply 4 cables L1/L2/L3/N 71A
	-	-	-
Circuit-breaker	(top/bottom power supply)	-	-
Tmax XT1	ED2217 L1 Top/L2 Bottom	-	-
	ED2225 L2 Top/L1 Bottom	-	-
	ED2233 L3 Top/N Bottom	-	-
Residual current	ED2241 N Top/L3 Bottom	-	-
Solenoid operator	ED2373 False pole module	-	-
	ED2381 False pole module	-	-
Circuit-breaker	(top power supply)	(bottom power supply)	-
Tmax XT3	ED2290 L1	ED2332 L1	-
	ED2308 L2	ED2340 L2	-
	ED2316 L3	ED2357 L3	-
Residual current	ED2324 N	ED2365 N	-
	ED2373 False pole module	-	-

⁽¹⁾ Select circuit-breakers in version with front terminals for copper cables.

TwinLine S 43 with CombiLine S

Examples of configurations

3

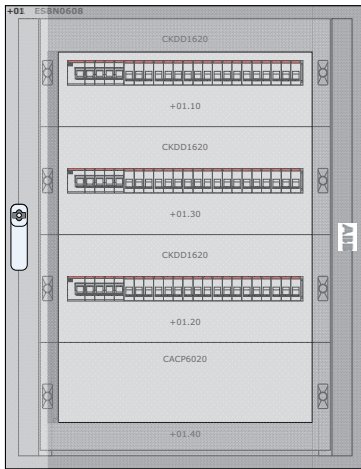

TwinLine S 43 (800 x 600 x 225 mm) IP43 and internal configuration CombiLine S

Type	Ord.no.	Description	Pcs.
ESBN0608	2CPX078111R9999	Rear wall, W 600 mm, H 800 mm	1
ESPG0600	2CPX078146R9999	Top/bottom plate (open/closed), D 225 mm, W 600 mm	1
ESSG0008	2CPX078129R9999	Side walls 2 pcs, D 225mm, H 800 mm	1
ESIN0008	2CPX078422R9999	Installation set for internal configuration, H 800 mm	1
TZ101	2CPX010450R9999	Flange for 52 entries	2
ESAT0608	2CPX078179R9999	Transparent door, W 600 mm, H 800 mm	1
CKDC1620	2CPX078321R9999	CombiLine S, DIN Components, Row distance 200 mm, 1 row, W 600 mm, H 200 mm	3
CACP6020	2CPX078353R9999	CombiLine S, Cover, plain, W 600 mm, H 200 mm	1

TwinLine S 43 with CombiLine S

Examples of configurations

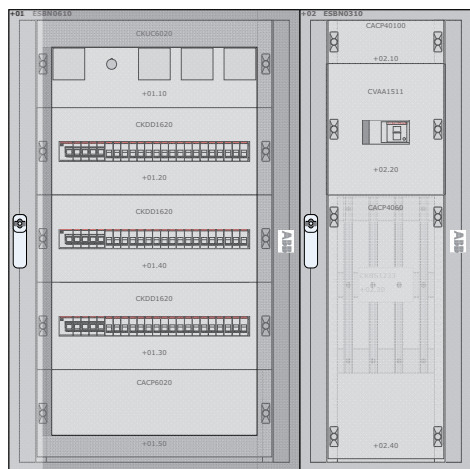

3

TwinLine S 43 (1000 x 600 x 225 mm + 1000 x 300 x 225 mm) IP43 Internal configuration CombiLine S, with busbars 250 A, 10 kA in external cable container

Type	Ord.no.	Description	Pcs.
ESBN0610	2CPX078112R9999	Rear wall, W 600 mm , H 1000 mm	1
ESPG0600	2CPX078146R9999	Top/bottom plate (open/closed), D 225 mm , W 600 mm	1
ESSG0010	2CPX078130R9999	Side walls 2 pcs, D 225 mm , H 1000 mm	1
ESAT0610	2CPX078180R9999	Transparent door, W 600 mm , H 1000 mm	1
ESBN0310	2CPX078103R9999	Rear wall, W 300 mm , H 1000 mm	1
ESPG0300	2CPX078145R9999	Top/bottom plate (open/closed), D 225 mm , W 300 mm	1
ESIN0010	2CPX078423R9999	Installation set for internal configuration, H 1000 mm	2
ESUG0010	2CPX078226R9999	Upright cabinet connection, D 225 mm , H 1000 mm	1
ESAS0310	2CPX078154R9999	Sheet steel door, W 300 mm , H 1000 mm	1
TZ101	2CPX010450R9999	Flange for 52 entries	3
CKDC1620	2CPX078321R9999	CombiLine S, DIN Components, Row distance 200 mm , 1 row, W 600 mm , H 200 mm	3
CACP6020	2CPX078353R9999	CombiLine S, Cover, plain, W 600 mm , H 200 mm	1
CKUC6020	2CPX078314R9999	CombiLine S, Measuring instruments, 4 pcs. 72x72 mm , W 600 mm , H 200 mm ,	1
CVAC1511	2CPX078269R9999	CombiLine S, Device vertical, W 300 mm , Tmax XT3, 1 device, 3/4 pole, fixed, lever operation	1
CACP3060	2CPX078348R9999	CombiLine S, Cover, plain, W 300 mm , H 600 mm	1
CACP3010	2CPX078341R9999	CombiLine S, Cover, plain, W 300 mm , H 100 mm	1
CASWP2	2CPX078454R9999	CombiLine S, Support, wiring duct, 2 pcs	3
CAHW6	2CPX078459R9999	CombiLine S, Mounting profile, for wiring system, W 600 mm	3
CKBS1231	2CPX078449R9999	CombiLine S, Busbar, support, flat busbars, holder scaled, W 300 mm , 1 support	3
BRO250		No. 2 flat busbars 250 A	1

TwinLine S 43 with CombiLine S

Examples of configurations

3

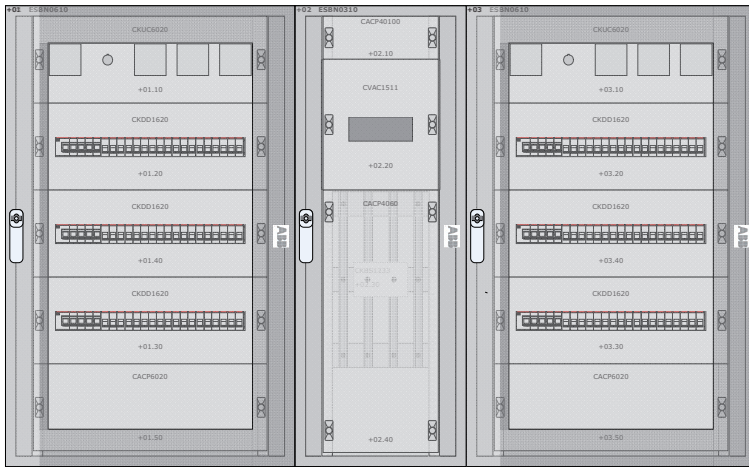

TwinLine S 43 (1000 x 600 x 225 mm + 1000 x 300 x 225 mm + 1000 x 600 x 225 mm) IP43, Internal configuration CombiLine S, with busbars 250 A,10 kA in external cable container

Type	Ord.no.	Description	Pcs.
ESBN0610	2CPX078112R9999	Rear wall, W 600 mm, H 1000 mm	2
ESPG0600	2CPX078146R9999	Top/bottom plate (open/closed), D 225 mm, W 600 mm	2
ESSG0010	2CPX078130R9999	Side walls 2 pcs, D 225 mm, H 1000 mm	1
ESIN0010	2CPX078423R9999	Installation set for internal configuration, H 1000 mm	3
ESAT0610	2CPX078180R9999	Transparent door, W 600 mm, H 1000 mm	2
ESBN0310	2CPX078103R9999	Rear wall, W 300 mm, H 1000 mm	1
ESPG0300	2CPX078145R9999	Top/bottom plate (open/closed), D 225 mm, W 300 mm	1
ESUG0010	2CPX078226R9999	Upright cabinet connection, D 225 mm, H 1000 mm	2
ESAS0310	2CPX078154R9999	Sheet steel door, W 300 mm, H 1000 mm	1
TZ101	2CPX010450R9999	Flange for 52 entries	5
CKDC1620	2CPX078321R9999	CombiLine S, DIN Components, Row distance 200 mm, 1 row, W 600 mm, H 200 mm	6
CKUC6020	2CPX078314R9999	CombiLine S, Measuring instruments, 4 pcs. 72x72 mm, W 600 mm, H 200 mm	2
CACP6020	2CPX078353R9999	CombiLine S, Cover, plain, W 600 mm, H 200 mm	2
CACP3060	2CPX078348R9999	CombiLine S, Cover, plain, W 300 mm, H 600 mm	1
CACP3010	2CPX078341R9999	CombiLine S, Cover, plain, W 300 mm, H 100 mm	1
CVAC1511	2CPX078269R9999	CombiLine S, Device vertical, W 300 mm, Tmax XT3, 1 device, 3/4 pole, fixed, lever operation	1
CASWP2	2CPX078454R9999	CombiLine S, Support, wiring duct, 2 pcs	6
CAHW6	2CPX078459R9999	CombiLine S, Mounting profile, for wiring system, W 600 mm	6
CKBS1231	2CPX078449R9999	CombiLine S, Busbar, support, flat busbars, holder scaled, W 300 mm, 1 support	3
BR0250		No. 2 flat busbars 250A	1

TwinLine S 43 with CombiLine S

Examples of configurations

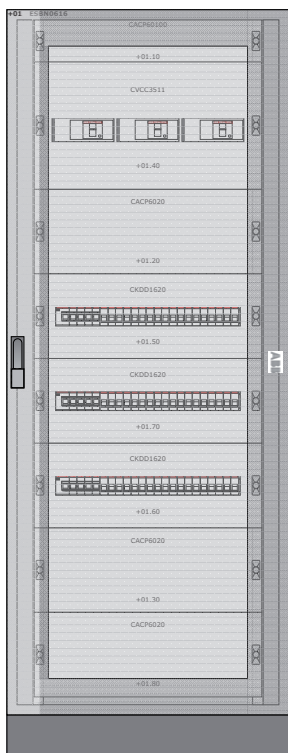

TwinLine S 43 (1600 x 600 x 275 mm) IP43

Internal configuration CombiLine S

Type	Ord.no.	Description	Pcs.
ESBN0616	2CPX078115R9999	Rear wall, W 600 mm, H 1600 mm	1
ESPL0600	2CPX078149R9999	Top/bottom plate (open/closed), D 275 mm, W 600 mm	1
ESSL0016	2CPX078142R9999	Side walls 2 pcs, D 275 mm, H 1600 mm	1
ESIN0016	2CPX078426R9999	Installation set for internal configuration, H 1600 mm	1
ESAL0610	2CPX078211R9999	Plinth, D 275 mm, W 600 mm, H 100 mm	1
ESAT0616	2CPX078183R9999	Transparent door, W 600 mm, H 1600 mm	1
TZ101	2CPX010450R9999	Flange for 52 entries	2
CKDC1620	2CPX078321R9999	CombiLine S, DIN Components, Row distance 200 mm, 1 row, W 600 mm, H 200 mm	3
CACP6010	2CPX078351R9999	CombiLine S, Cover, plain, W 600 mm, H 100 mm	1
CVCC3511	2CPX078400R9999	CombiLine S, Device vertical, W 600 mm, Tmax XT3, 3 device, 3/4 pole, fixed, lever operation	1
CACP6020	2CPX078353R9999	CombiLine S, Cover, plain, W 600 mm, H 200 mm	3
CASWP2	2CPX078454R9999	CombiLine S, Support, wiring duct, 2 pcs	3
CAHW6	2CPX078459R9999	CombiLine S, Mounting profile, for wiring system, W 600 mm	3

TwinLine S 43 with CombiLine S

Examples of configurations

3

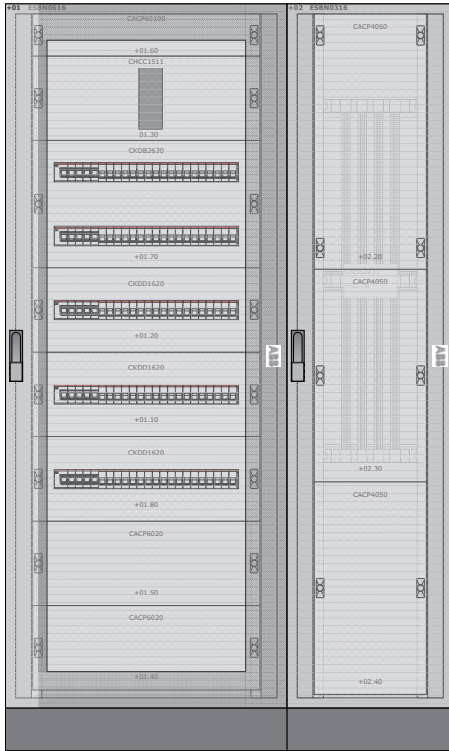

TwinLine S 43 (1600 x 600x 225 mm + 1600 x 300 x 225 mm) IP43
Internal configuration CombiLine S, with busbars 400 A, 23 kA in external cable container

Type	Ord.no.	Description	Pcs.
ESBN0616	2CPX078115R9999	Rear wall, W 600 mm, H 1600 mm	1
ESPG0600	2CPX078146R9999	Top/bottom plate (open/closed), D 225 mm, W 600 mm	1
ESSG0016	2CPX078133R9999	Side walls 2 pcs, D 225 mm, H 1600 mm	1
ESIN0016	2CPX078426R9999	Installation set for internal configuration, H 1600 mm	2
ESAG0610	2CPX078205R9999	Plinth, D 225 mm, W 600 mm, H 100 mm	1
ESAT0616	2CPX078183R9999	Transparent door, W 600 mm, H 1600 mm	1
ESBN0316	2CPX078106R9999	Rear wall, W 300 mm, H 1600 mm	1
ESPG0300	2CPX078145R9999	Top/bottom plate (open/closed), D 225 mm, W 300 mm	1
ESUG0016	2CPX078229R9999	Upright cabinet connection, D 225 mm, H 1600 mm	1
ESAG0310	2CPX078203R9999	Plinth, D 225 mm, W 300 mm, H 100 mm	1
ESAS0316	2CPX078157R9999	Sheet steel door, W 300 mm, H 1600 mm	1
TZ101	2CPX010450R9999	Flange for 52 entries	3
CKDC1620	2CPX078321R9999	CombiLine S, DIN Components, Row distance 200 mm, 1 row, W 600 mm, H 200 mm	3
CACP6010	2CPX078351R9999	CombiLine S, Cover, plain, W 600 mm, H 100 mm	1
CHCC1511	2CPX078243R9999	CombiLine S, Device horizontal, W 600 mm, Tmax XT3, 1 device, 3/4 pole, fixed, lever operation	1
CACP6020	2CPX078353R9999	CombiLine S, Cover, plain, W 600 mm, H 200 mm	2
CKDB2630	2CPX078406R9999	CombiLine S, DIN Components, Row distance 150 mm, 2 row, W 600 mm, H 300 mm	1
CACP3060	2CPX078348R9999	CombiLine S, Cover, plain, W 300 mm, H 600 mm	1
CACP3050	2CPX078347R9999	CombiLine S, Cover, plain, W 300 mm, H 500 mm	2
CASWP2	2CPX078454R9999	CombiLine S, Support, wiring duct, 2 pcs	5
CAHW6	2CPX078459R9999	CombiLine S, Mounting profile, for wiring system, W 600 mm	5
CASVP2	2CPX078452R9999	CombiLine S, Support, vertical universal, 2 pcs	2
CKBS2231	2CPX078372R9999	CombiLine S, Busbar, support, shaped busbars, holder scaled, W 300 mm, 1 support	4
BA0400		Busbar In = 400A	2

TwinLine S 43 with CombiLine S

Examples of configurations

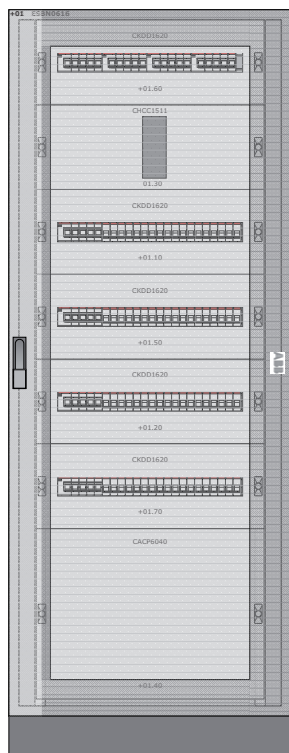

TwinLine S 43 (1600 x 600 x 225 mm) IP43 Internal configuration CombiLine S

Type	Ord.no.	Description	Pcs.
ESBNO618	2CPX078116R9999	Rear wall, W 600 mm, H 1800 mm	1
ESPG0600	2CPX078146R9999	Top/bottom plate (open/closed), D 225 mm, W 600 mm	1
ESSG0018	2CPX078134R9999	Side walls 2 pcs, D 225 mm, H 1800 mm	1
ESIN0018	2CPX078427R9999	Installation set for internal configuration, H 1800 mm	1
ESAG0610	2CPX078205R9999	Plinth, D 225 mm, W 600 mm, H 100 mm	1
ESAT0618	2CPX078184R9999	Transparent door, W 600 mm, H 1800 mm	1
TZ101	2CPX010450R9999	Flange for 52 entries	2
CKDC1620	2CPX078321R9999	CombiLine S, DIN Components, Row distance 200 mm, 1 row, W 600 mm, H 200 mm	5
CHCC1511	2CPX078243R9999	CombiLine S, Device horizontal, W 600 mm, Tmax XT3, 1 device, 3/4 pole, fixed, lever operation	1
CACP6040	2CPX078356R9999	CombiLine S, Cover, plain, W 600 mm, H 400 mm	1
CASWP2	2CPX078454R9999	CombiLine S, Support, wiring duct, 2 pcs	6
CAHW6	2CPX078459R9999	CombiLine S, Mounting profile, for wiring system, W 600 mm	6

TwinLine S 43 with CombiLine S

Examples of configurations

3

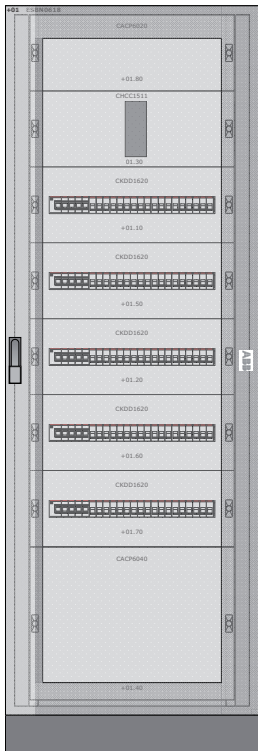

TwinLine S 43 (1800 x 600x 275 mm + Busbar 250 A, 25 kA) IP43 Internal configuration CombiLine S, with busbars 250 A, 16 kA

Type	Ord.no.	Description	Pcs.
ESBN0618	2CPX078116R9999	Rear wall, W 600 mm, H 1800 mm	1
ESPL0600	2CPX078149R9999	Top/bottom plate (open/closed), D 275 mm, W 600 mm	1
ESSL0018	2CPX078143R9999	Side walls 2 pcs, D 275 mm, H 1800 mm	1
ESIN0018	2CPX078427R9999	Installation set for internal configuration, H 1800 mm	1
ESAL0610	2CPX078211R9999	Plinth, D 275 mm, W 600 mm, H 100 mm	1
ESAT0618	2CPX078184R9999	Transparent door, W 600 mm, H 1800 mm	1
TZ101	2CPX010450R9999	Flange for 52 entries	2
CKDC1620	2CPX078321R9999	CombiLine S, DIN Components, Row distance 200 mm, 1 row, W 600 mm, H 200 mm	5
CHCC1511	2CPX078243R9999	CombiLine S, Device horizontal, W 600 mm, Tma x xT3, 1 device, 3/4 pole, fixed, lever operation	1
CACPD020	2CPX078356R9999	CombiLine S, Cover, plain, W 600 mm, H 400 mm	1
CASWP2	2CPX078454R9999	CombiLine S, Support, wiring duct, 2 pcs	5
CAHW6	2CPX078459R9999	CombiLine S, Mounting profile, for wiring system, W 600 mm	5
CKBS1161	2CPX078447R9999	CombiLine S, Busbar, support, flat busbars, holder linear, W 600 mm, 1 support	4
BR0250		No. 2 flat busbars 250 A	4

TwinLine S 43 with CombiLine S

Examples of configurations

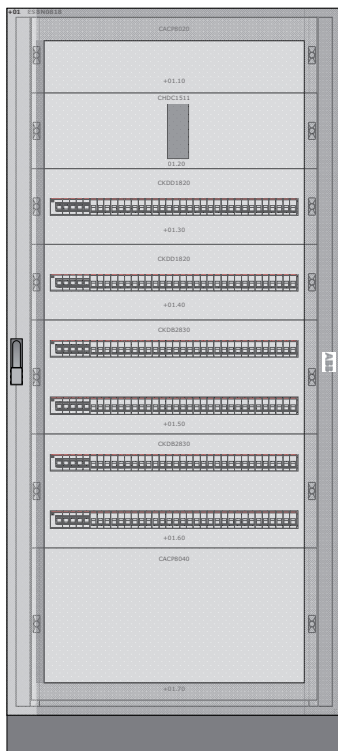

TwinLine S 43 (1800 x 800 x 275 mm) IP43 Internal configuration CombiLine S

Type	Ord.no.	Description	Pcs.
ESBN0818	2CPX078125R9999	Rear wall, W 800 mm, H 1800 mm	1
ESPL0800	2CPX078150R9999	Top/bottom plate (open/closed), D 275 mm, W 800 mm	1
ESSL0018	2CPX078143R9999	Side walls 2 pcs, D 275 mm, H 1800 mm	1
ESIN0018	2CPX078427R9999	Installation set for internal configuration, H 1800 mm	1
TZ101	2CPX010450R9999	Flange for 52 entries	3
ESAL0810	2CPX078213R9999	Plinth, D 275 mm, W 800 mm, H 100 mm	1
ESAT0818	2CPX078192R9999	Transparent door, W 800 mm, H 1800 mm	1
CKDC1820	2CPX078322R9999	CombiLine S, DIN Components, Row distance 200 mm, 1 row, W 800 mm, H 200 mm	2
CKDB2830	2CPX078407R9999	CombiLine S, DIN Components, Row distance 150 mm, 2 row, W 800 mm, H 300 mm	2
CHDC1511	2CPX078250R9999	CombiLine S, Device horizontal, W 800 mm, Tmax XT3, 1 device, 3/4 pole, fixed, lever operation	1
CACP8020	2CPX078363R9999	CombiLine S, Cover, plain, W 800 mm, H 200 mm	1
CACP8040	2CPX078366R9999	CombiLine S, Cover, plain, W 800 mm, H 400 mm	1
CASWP2	2CPX078454R9999	CombiLine S, Support, wiring duct, 2 pcs	6
CAHW8	2CPX078461R9999	CombiLine S, Mounting profile, for wiring system, W 800 mm	6

TwinLine S 43 with CombiLine S

Examples of configurations

3

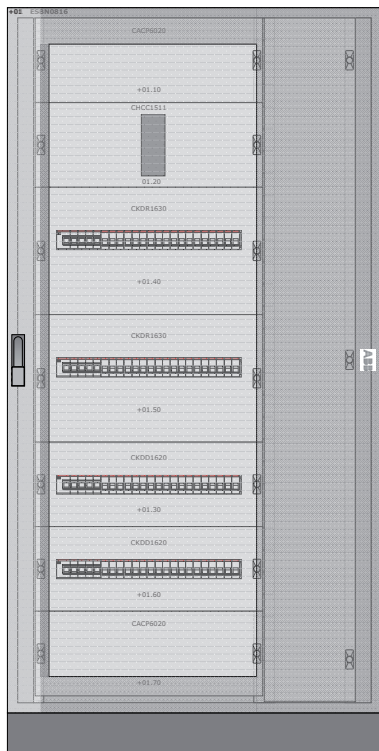

TwinLine S 43 (1600 x 800 x 225 mm) IP43 and internal cable container Internal configuration CombiLine S

Type	Ord.no.	Description	Pcs.
ESBN0816	2CPX078124R9999	Rear wall, W 800 mm, H 1600 mm	1
ESPG0800	2CPX078147R9999	Top/bottom plate (open/closed), D 225 mm, W 800 mm	1
ESSG0016	2CPX078133R9999	Side walls 2 pcs, D 225 mm, H 1600 mm	1
ESIN0016	2CPX078426R9999	Installation set for internal configuration, H 1600 mm	1
ESAI0216	2CPX078220R9999	Internal cable container, H 1600 mm	1
ESAG0810	2CPX078207R9999	Plinth, D 225 mm, W 800 mm, H 100 mm	1
ESAT2616	2CPX078199R9999	Transparent door, for internal cable container, W 800 mm, H 1600 mm	1
TZ101	2CPX010450R9999	Flange for 52 entries	3
CKDC1620	2CPX078321R9999	CombiLine S, DIN Components, Row distance 200 mm, 1 row, W 600 mm, H 200 mm	2
CHCC1511	2CPX078243R9999	CombiLine S, Device horizontal, W 600 mm, Tmax XT3, 1 device, 3/4 pole, fixed, lever operation	1
CACP6020	2CPX078353R9999	CombiLine S, Cover, plain, W 600 mm, H 200 mm	2
CKDR1630	2CPX078383R9999	CombiLine S, DIN Components, Tmax breaker + RC mod, 1 row, W 600 mm, H 300 mm	2
CASWP2	2CPX078454R9999	CombiLine S, Support, wiring duct, 2 pcs	4
CAHW6	2CPX078459R9999	CombiLine S, Mounting profile, for wiring system, W 600 mm	4

TwinLine S 43 with CombiLine S

Examples of configurations

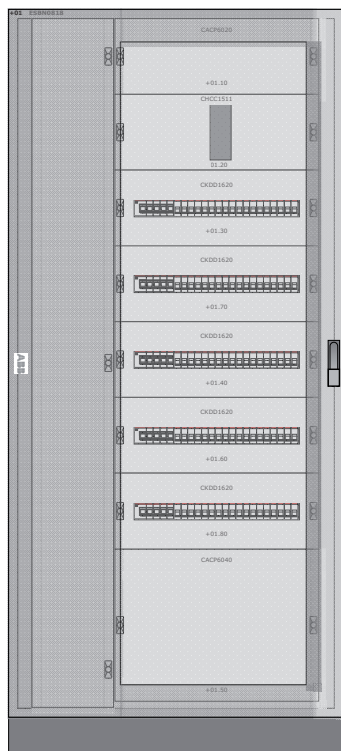

TwinLine S 43 (1800 x 800 x 275 m) IP43 and internal cable container
Internal configuration CombiLine S

Type	Ord.no.	Description	Pcs.
ESBN0818	2CPX078125R9999	Rear wall, W 800 mm, H 1800 mm	1
ESPL0800	2CPX078150R9999	Top/bottom plate (open/closed), D 275 mm, W 800 mm	1
ESSL0018	2CPX078143R9999	Side walls 2 pcs, D 275 mm, H 1800 mm	1
ESIN0018	2CPX078427R9999	Installation set for internal configuration, H 1800 mm	1
ESAI0218	2CPX078221R9999	Internal cable container, H 1800 mm	1
ESAL0810	2CPX078213R9999	Plinth, D 275 mm, W 800 mm, H 100 mm	1
ESAT2618	2CPX078200R9999	Transparent door, for internal cable container, W 800 mm, H 1800 mm	1
TZ101	2CPX010450R9999	Flange for 52 entries	3
CKDC1620	2CPX078321R9999	CombiLine S, DIN Components, Row distance 200 mm, 1 row, W 600 mm, H 200 mm	5
CHCC1511	2CPX078243R9999	CombiLine S, Device horizontal, W 600 mm, Tmax XT3, 1 device, 3/4 pole, fixed, lever operation	1
CACP6020	2CPX078353R9999	CombiLine S, Cover, plain, W 600 mm, H 200 mm	1
CACP6040	2CPX078356R9999	CombiLine S, Cover, plain, W 600 mm, H 400 mm	1
CASWP2	2CPX078454R9999	CombiLine S, Support, wiring duct, 2 pcs	5
CAHW6	2CPX078459R9999	CombiLine S, Mounting profile, for wiring system, W 600 mm	5

Type	Ord. No.	EAN Code	Product-code	Price	Page
CACP3005	2CPX078340R9999	4011617783404	809010		56
CACP3010	2CPX078341R9999	4011617783411	809010		56
CACP3015	2CPX078342R9999	4011617783428	809010		56
CACP3020	2CPX078343R9999	4011617783435	809010		56
CACP3025	2CPX078344R9999	4011617783442	809010		56
CACP3030	2CPX078345R9999	4011617783459	809010		56
CACP3040	2CPX078346R9999	4011617783466	809010		56
CACP3050	2CPX078347R9999	4011617783473	809010		56
CACP3060	2CPX078348R9999	4011617783480	809010		56
CACP3080	2CPX078349R9999	4011617783497	809010		56
CACP6005	2CPX078350R9999	4011617783503	809010		56
CACP6010	2CPX078351R9999	4011617783510	809010		56
CACP6015	2CPX078352R9999	4011617783527	809010		56
CACP6020	2CPX078353R9999	4011617783534	809010		56
CACP6025	2CPX078354R9999	4011617783541	809010		56
CACP6030	2CPX078355R9999	4011617783558	809010		56
CACP6040	2CPX078356R9999	4011617783565	809010		56
CACP6050	2CPX078357R9999	4011617783572	809010		56
CACP6060	2CPX078358R9999	4011617783589	809010		56
CACP6080	2CPX078359R9999	4011617783596	809010		56
CACP8005	2CPX078360R9999	4011617783602	809010		56
CACP8010	2CPX078361R9999	4011617783619	809010		56
CACP8015	2CPX078362R9999	4011617783626	809010		56
CACP8020	2CPX078363R9999	4011617783633	809010		56
CACP8025	2CPX078364R9999	4011617783640	809010		56
CACP8030	2CPX078365R9999	4011617783657	809010		56
CACP8040	2CPX078366R9999	4011617783664	809010		56
CACP8050	2CPX078367R9999	4011617783671	809010		56
CACP8060	2CPX078368R9999	4011617783688	809010		56
CACP8080	2CPX078369R9999	4011617783695	809010		56
CAEC6	2CPX078462R9999	4011617784623	809010		57
CAHB3	2CPX078456R9999	4011617784562	809010		64
CAHB6	2CPX078457R9999	4011617784579	809010		64
CAHB8	2CPX078458R9999	4011617784586	809010		64
CAHCP10	2CPX078485R9999	4011617784852	809010		57
CAHW6	2CPX078459R9999	4011617784593	809010		65
CAHW8	2CPX078461R9999	4011617784616	809010		65
CAMF3030	2CPX078323R9999	4011617783237	809010		58
CAMF6015	2CPX078324R9999	4011617783244	809010		58
CAMF6020	2CPX078325R9999	4011617783251	809010		58
CAMF6025	2CPX078326R9999	4011617783268	809010		58
CAMF6030	2CPX078327R9999	4011617783275	809010		58
CAMF6040	2CPX078328R9999	4011617783282	809010		58
CAMF6050	2CPX078329R9999	4011617783299	809010		58
CAMF6060	2CPX078330R9999	4011617783305	809010		58
CAMF6080	2CPX078331R9999	4011617783312	809010		58
CAMF8015	2CPX078332R9999	4011617783329	809010		58
CAMF8020	2CPX078333R9999	4011617783336	809010		58
CAMF8025	2CPX078334R9999	4011617783343	809010		58
CAMF8030	2CPX078335R9999	4011617783350	809010		58
CAMF8040	2CPX078336R9999	4011617783367	809010		58
CAMF8050	2CPX078337R9999	4011617783374	809010		58
CAMF8060	2CPX078338R9999	4011617783381	809010		58
CAMF8080	2CPX078339R9999	4011617783398	809010		58
CASHP2	2CPX078450R9999	4011617784500	809010		62
CASHP2	2CPX078450R9999	4011617784500	809010		64
CASHP50	2CPX078451R9999	4011617784517	809010		62
CASHP50	2CPX078451R9999	4011617784517	809010		64
CASVP2	2CPX078452R9999	4011617784524	809010		64
CASVP50	2CPX078453R9999	4011617784531	809010		64
CASWP2	2CPX078454R9999	4011617784548	809010		65
CASWP50	2CPX078455R9999	4011617784555	809010		65
CHCA1511	2CPX078241R9999	4011617782414	809010		48
CHCA1611	2CPX078255R9999	4011617782551	809010		48
CHCB1511	2CPX078242R9999	4011617782421	809010		48
CHCB1611	2CPX078256R9999	4011617782568	809010		48
CHCC1511	2CPX078243R9999	4011617782438	809010		48
CHCC1611	2CPX078257R9999	4011617782575	809010		48
CHCD1511	2CPX078244R9999	4011617782445	809010		48
CHCD1611	2CPX078258R9999	4011617782582	809010		48
CHCE1511	2CPX078245R9999	4011617782452	809010		48

Type	Ord. No.	EAN Code	Product-code	Price	Page
CHCE1611	2CPX078259R9999	4011617782599	809010		48
CHCF1511	2CPX078246R9999	4011617782469	809010		48
CHCF1611	2CPX078260R9999	4011617782605	809010		48
CHCG1511	2CPX078247R9999	4011617782476	809010		48
CHCQ1513	2CPX078302R9999	4011617783022	809010		52
CHCR1513	2CPX078377R9999	4011617783770	809010		52
CHDA1511	2CPX078248R9999	4011617782483	809010		48
CHDA1611	2CPX078261R9999	4011617782612	809010		48
CHDB1511	2CPX078249R9999	4011617782490	809010		48
CHDB1611	2CPX078262R9999	4011617782629	809010		48
CHDC1511	2CPX078250R9999	4011617782506	809010		48
CHDC1611	2CPX078263R9999	4011617782636	809010		48
CHDD1511	2CPX078251R9999	4011617782513	809010		48
CHDD1611	2CPX078264R9999	4011617782643	809010		48
CHDE1511	2CPX078252R9999	4011617782520	809010		48
CHDE1611	2CPX078265R9999	4011617782650	809010		48
CHDF1511	2CPX078253R9999	4011617782537	809010		48
CHDF1611	2CPX078266R9999	4011617782667	809010		48
CHDG1511	2CPX078254R9999	4011617782544	809010		48
CHDQ1513	2CPX078303R9999	4011617783039	809010		52
CHDR1513	2CPX078378R9999	4011617783787	809010		52
CKBS1161	2CPX078447R9999	4011617784470	809010		60
CKBS1181	2CPX078448R9999	4011617784487	809010		60
CKBS1231	2CPX078449R9999	4011617784494	809010		60
CKBS2161	2CPX078370R9999	4011617783701	809010		60
CKBS2181	2CPX078371R9999	4011617783718	809010		60
CKBS2231	2CPX078372R9999	4011617783725	809010		60
CKDB1615	2CPX078318R9999	4011617783183	809010		54
CKDB1815	2CPX078319R9999	4011617783190	809010		54
CKDB2630	2CPX078406R9999	4011617784067	809010		54
CKDB2830	2CPX078407R9999	4011617784074	809010		54
CKDC1320	2CPX078320R9999	4011617783206	809010		54
CKDC1620	2CPX078321R9999	4011617783213	809010		54
CKDC1820	2CPX078322R9999	4011617783220	809010		54
CKDR1630	2CPX078383R9999	4011617783831	809010		55
CKDR1830	2CPX078384R9999	4011617783848	809010		55
CKDU1630	2CPX078385R9999	4011617783855	809010		55
CKDU1830	2CPX078386R9999	4011617783862	809010		55
CKFH1620	2CPX078463R9999	4011617784630	809010		59
CKFH1820	2CPX078464R9999	4011617784647	809010		59
CKFH2620	2CPX078465R9999	4011617784654	809010		59
CKFH2820	2CPX078466R9999	4011617784661	809010		59
CKFH3620	2CPX078467R9999	4011617784678	809010		59
CKFH3820	2CPX078468R9999	4011617784685	809010		59
CKFV8060	2CPX078469R9999	4011617784692	809010		59
CKFV8080	2CPX078470R9999	4011617784708	809010		59
CKFV8100	2CPX078471R9999	4011617784715	809010		59
CKFV8120	2CPX078472R9999	4011617784722	809010		59
CKFV8140	2CPX078473R9999	4011617784739	809010		59
CKFV8160	2CPX078474R9999	4011617784746	809010		59
CKFV8180	2CPX078475R9999	4011617784753	809010		59
CKFV8200	2CPX078476R9999	4011617784760	809010		59
CKFV9060	2CPX078477R9999	4011617784777	809010		59
CKFV9080	2CPX078478R9999	4011617784784	809010		59
CKFV9100	2CPX078479R9999	4011617784791	809010		59
CKFV9120	2CPX078480R9999	4011617784807	809010		59
CKFV9140	2CPX078481R9999	4011617784814	809010		59
CKFV9160	2CPX078482R9999	4011617784821	809010		59
CKFV9180	2CPX078483R9999	4011617784838	809010		59
CKFV9200	2CPX078484R9999	4011617784845	809010		59
CKUA6020	2CPX078310R9999	4011617783107	809010		57
CKUA8020	2CPX078311R9999	4011617783114	809010		57
CKUB6020	2CPX078312R9999	4011617783121	809010		57
CKUB8020	2CPX078313R9999	4011617783138	809010		57
CKUC6020	2CPX078314R9999	4011617783145	809010		57
CKUC8020	2CPX078315R9999	4011617783152	809010		57
CKUD6020	2CPX078316R9999	4011617783169	809010		57
CKUD8020	2CPX078317R9999	4011617783176	809010		57
CVAA1511	2CPX078267R9999	4011617782674	809010		49
CVAA1611	2CPX078284R9999	4011617782841	809010		50
CVAB1511	2CPX078268R9999	4011617782681	809010		49

Index

Type	Ord. No.	EAN Code	Product-code	Price	Page	Type	Ord. No.	EAN Code	Product-code	Price	Page
CVAB1611	2CPX078285R9999	4011617782858	809010		50	ESAC2008	2CPX010915R9999	4011617109150	704010		27
CVAC1511	2CPX078269R9999	4011617782698	809010		49	ESAC2010	2CPX010916R9999	4011617109167	704010		27
CVAC1611	2CPX078286R9999	4011617782865	809010		50	ESAC2012	2CPX010917R9999	4011617109174	704010		27
CVAD1511	2CPX078270R9999	4011617782704	809010		49	ESAC2014	2CPX010918R9999	4011617109181	704010		27
CVAD1611	2CPX078287R9999	4011617782872	809010		50	ESAC2016	2CPX010919R9999	4011617109198	704010		27
CVAE1611	2CPX078288R9999	4011617782889	809010		50	ESAC2018	2CPX010920R9999	4011617109204	704010		27
CVAF1611	2CPX078289R9999	4011617782896	809010		50	ESAC2020	2CPX010921R9999	4011617109211	704010		27
CVAH1511	2CPX078271R9999	4011617782711	809010		49	ESAC3001P2	2CPX078410R9999	4011617784104	704010		28
CVAP1513	2CPX078304R9999	4011617783046	809010		53	ESAC3002	2CPX078411R9999	4011617784111	704010		28
CVAP1514	2CPX078307R9999	4011617783077	809010		53	ESAC3003P4	2CPX078412R9999	4011617784128	704010		28
CVCA1511	2CPX078272R9999	4011617782728	809010		49	ESAC3004P2	2CPX078413R9999	4011617784135	704010		28
CVCA1611	2CPX078290R9999	4011617782902	809010		50	ESAG0305	2CPX078202R9999	4011617782025	704030		25
CVCA3511	2CPX078398R9999	4011617783985	809010		51	ESAG0310	2CPX078203R9999	4011617782032	704030		25
CVCB1511	2CPX078273R9999	4011617782735	809010		49	ESAG0605	2CPX078204R9999	4011617782049	704030		25
CVCB1611	2CPX078291R9999	4011617782919	809010		50	ESAG0610	2CPX078205R9999	4011617782056	704030		25
CVCB3511	2CPX078399R9999	4011617783992	809010		51	ESAG0805	2CPX078206R9999	4011617782063	704030		25
CVCC1511	2CPX078274R9999	4011617782742	809010		49	ESAG0810	2CPX078207R9999	4011617782070	704030		25
CVCC1611	2CPX078292R9999	4011617782926	809010		50	ESAI0206	2CPX078215R9999	4011617782155	704010		21
CVCC3511	2CPX078400R9999	4011617784005	809010		51	ESAI0208	2CPX078216R9999	4011617782162	704010		21
CVCD1511	2CPX078275R9999	4011617782759	809010		49	ESAI0210	2CPX078217R9999	4011617782179	704010		21
CVCD1611	2CPX078293R9999	4011617782933	809010		50	ESAI0212	2CPX078218R9999	4011617782186	704010		21
CVCD3511	2CPX078401R9999	4011617784012	809010		51	ESAI0214	2CPX078219R9999	4011617782193	704010		21
CVCE1611	2CPX078294R9999	4011617782940	809010		50	ESAI0216	2CPX078220R9999	4011617782209	704010		21
CVCF1611	2CPX078295R9999	4011617782957	809010		50	ESAI0218	2CPX078221R9999	4011617782216	704010		21
CVCG1511	2CPX078277R9999	4011617782773	809010		49	ESAI0220	2CPX078222R9999	4011617782223	704010		21
CVCH1511	2CPX078276R9999	4011617782766	809010		49	ESAL0305	2CPX078208R9999	4011617782087	704030		25
CVCQ1513	2CPX078305R9999	4011617783053	809010		53	ESAL0310	2CPX078209R9999	4011617782094	704030		25
CVCQ1514	2CPX078308R9999	4011617783084	809010		53	ESAL0605	2CPX078210R9999	4011617782100	704030		25
CVCR1513	2CPX078379R9999	4011617783794	809010		53	ESAL0610	2CPX078211R9999	4011617782117	704030		25
CVCR1514	2CPX078381R9999	4011617783817	809010		53	ESAL0805	2CPX078212R9999	4011617782124	704030		25
CVDA1511	2CPX078278R9999	4011617782780	809010		49	ESAL0810	2CPX078213R9999	4011617782131	704030		25
CVDA1611	2CPX078296R9999	4011617782964	809010		50	ESAS0304	2CPX078151R9999	4011617781516	704050		22
CVDA4511	2CPX078402R9999	4011617784029	809010		51	ESAS0306	2CPX078152R9999	4011617781523	704050		22
CVDB1511	2CPX078279R9999	4011617782797	809010		49	ESAS0308	2CPX078153R9999	4011617781530	704050		22
CVDB1611	2CPX078297R9999	4011617782971	809010		50	ESAS0310	2CPX078154R9999	4011617781547	704050		22
CVDB4511	2CPX078403R9999	4011617784036	809010		51	ESAS0312	2CPX078155R9999	4011617781554	704050		22
CVDC1511	2CPX078280R9999	4011617782803	809010		49	ESAS0314	2CPX078156R9999	4011617781561	704050		22
CVDC1611	2CPX078298R9999	4011617782988	809010		50	ESAS0316	2CPX078157R9999	4011617781578	704050		22
CVDC4511	2CPX078404R9999	4011617784043	809010		51	ESAS0318	2CPX078158R9999	4011617781585	704050		22
CVDD1511	2CPX078281R9999	4011617782810	809010		49	ESAS0320	2CPX078159R9999	4011617781592	704050		22
CVDD1611	2CPX078299R9999	4011617782995	809010		50	ESAS0604	2CPX078160R9999	4011617781608	704050		22
CVDD4511	2CPX078405R9999	4011617784050	809010		51	ESAS0606	2CPX078161R9999	4011617781615	704050		22
CVDE1611	2CPX078300R9999	4011617783008	809010		50	ESAS0608	2CPX078162R9999	4011617781622	704050		22
CVDF1611	2CPX078301R9999	4011617783015	809010		50	ESAS0610	2CPX078163R9999	4011617781639	704050		22
CVDG1511	2CPX078283R9999	4011617782834	809010		49	ESAS0612	2CPX078164R9999	4011617781646	704050		22
CVDH1511	2CPX078282R9999	4011617782827	809010		49	ESAS0614	2CPX078165R9999	4011617781653	704050		22
CVDQ1513	2CPX078306R9999	4011617783060	809010		53	ESAS0616	2CPX078166R9999	4011617781660	704050		22
CVDQ1514	2CPX078309R9999	4011617783091	809010		53	ESAS0618	2CPX078167R9999	4011617781677	704050		22
CVDR1513	2CPX078380R9999	4011617783800	809010		53	ESAS0620	2CPX078168R9999	4011617781684	704050		22
CVDR1514	2CPX078382R9999	4011617783824	809010		53	ESAS0804	2CPX078169R9999	4011617781691	704050		22
ED44P10	2CPX062335R9999	4011617623359	701010		65	ESAS0806	2CPX078170R9999	4011617781707	704050		22
ED44P1000	2CPX062703R9999	4011617627036	701010		65	ESAS0808	2CPX078171R9999	4011617781714	704050		22
ED44P50	2CPX062308R9999	4011617623083	701010		65	ESAS0810	2CPX078172R9999	4011617781721	704050		22
ED45P10	2CPX062336R9999	4011617623366	701010		65	ESAS0814	2CPX078174R9999	4011617781745	704050		22
ED45P1000	2CPX062704R9999	4011617627043	701010		65	ESAS0816	2CPX078175R9999	4011617781752	704050		22
ED45P50	2CPX062310R9999	4011617623106	701010		65	ESAS0818	2CPX078176R9999	4011617781769	704050		22
ESAC1001	2CPX010900R9999	4011617109006	704010		26	ESAS0820	2CPX078177R9999	4011617781776	704050		22
ESAC1002	2CPX010901R9999	4011617109013	704010		26	ESAT0606	2CPX078178R9999	4011617781783	704050		23
ESAC1003	2CPX010902R9999	4011617109020	704010		26	ESAT0608	2CPX078179R9999	4011617781790	704050		23
ESAC1004	2CPX010903R9999	4011617109037	704010		26	ESAT0610	2CPX078180R9999	4011617781806	704050		23
ESAC1005	2CPX010904R9999	4011617109044	704010		26	ESAT0612	2CPX078181R9999	4011617781813	704050		23
ESAC1006	2CPX010905R9999	4011617109051	704010		26	ESAT0614	2CPX078182R9999	4011617781820	704050		23
ESAC1007	2CPX010906R9999	4011617109068	704010		26	ESAT0616	2CPX078183R9999	4011617781837	704050		23
ESAC1008	2CPX010907R9999	4011617109075	704010		26	ESAT0618	2CPX078184R9999	4011617781844	704050		23
ESAC1009	2CPX010908R9999	4011617109082	704010		26	ESAT0620	2CPX078185R9999	4011617781851	704050		23
ESAC1010	2CPX010909R9999	4011617109099	704010		26	ESAT0806	2CPX078186R9999	4011617781868	704050		23
ESAC1011	2CPX010910R9999	4011617109105	704010		26	ESAT0808	2CPX078187R9999	4011617781875	704050		23
ESAC1012	2CPX010911R9999	4011617109112	704010		26	ESAT0810	2CPX078188R9999	4011617781882	704050		23
ESAC1013	2CPX010912R9999	4011617109129	704010		26	ESAT0812	2CPX078189R9999	4011617781899	704050		23
ESAC2004	2CPX010913R9999	4011617109136	704010		27	ESAT0814	2CPX078190R9999	4011617781905	704050		23
ESAC2006	2CPX010914R9999	4011617109143	704010		27	ESAT0816	2CPX078191R9999	4011617781912	704050		23

Type	Ord. No.	EAN Code	Product-code	Price	Page
ESAT0818	2CPX078192R9999	4011617781929	704050		23
ESAT0820	2CPX078193R9999	4011617781936	704050		23
ESAT2606	2CPX078194R9999	4011617781943	704050		23
ESAT2608	2CPX078195R9999	4011617781950	704050		23
ESAT2610	2CPX078196R9999	4011617781967	704050		23
ESAT2612	2CPX078197R9999	4011617781974	704050		23
ESAT2614	2CPX078198R9999	4011617781981	704050		23
ESAT2616	2CPX078199R9999	4011617781998	704050		23
ESAT2618	2CPX078200R9999	4011617782001	704050		23
ESAT2620	2CPX078201R9999	4011617782018	704050		23
ESBN0304	2CPX078100R9999	4011617781004	901010		18
ESBN0306	2CPX078101R9999	4011617781011	901010		18
ESBN0308	2CPX078102R9999	4011617781028	901010		18
ESBN0310	2CPX078103R9999	4011617781035	901010		18
ESBN0312	2CPX078104R9999	4011617781042	901010		18
ESBN0314	2CPX078105R9999	4011617781059	902010		18
ESBN0316	2CPX078106R9999	4011617781066	902010		18
ESBN0318	2CPX078107R9999	4011617781073	902010		18
ESBN0320	2CPX078108R9999	4011617781080	902010		18
ESBN0604	2CPX078109R9999	4011617781097	901010		18
ESBN0606	2CPX078110R9999	4011617781103	901010		18
ESBN0608	2CPX078111R9999	4011617781110	901010		18
ESBN0610	2CPX078112R9999	4011617781127	901010		18
ESBN0612	2CPX078113R9999	4011617781134	901010		18
ESBN0614	2CPX078114R9999	4011617781141	902010		18
ESBN0616	2CPX078115R9999	4011617781158	902010		18
ESBN0618	2CPX078116R9999	4011617781165	902010		18
ESBN0620	2CPX078117R9999	4011617781172	902010		18
ESBN0804	2CPX078118R9999	4011617781189	901010		18
ESBN0808	2CPX078120R9999	4011617781202	901010		18
ESBN0810	2CPX078121R9999	4011617781219	901010		18
ESBN0812	2CPX078122R9999	4011617781226	901010		18
ESBN0814	2CPX078123R9999	4011617781233	902010		18
ESBN0816	2CPX078124R9999	4011617781240	902010		18
ESBN0818	2CPX078125R9999	4011617781257	902010		18
ESBN0820	2CPX078126R9999	4011617781264	902010		18
ESCG0600	2CPX078373R9999	4011617783732	905010		19
ESCG0800	2CPX078374R9999	4011617783749	905010		19
ESCL0600	2CPX078375R9999	4011617783756	905010		19
ESCL0800	2CPX078376R9999	4011617783763	905010		19
ESIN0004	2CPX078420R9999	4011617784203	704010		21
ESIN0006	2CPX078421R9999	4011617784210	704010		21
ESIN0008	2CPX078422R9999	4011617784227	704010		21
ESIN0010	2CPX078423R9999	4011617784234	704010		21
ESIN0012	2CPX078424R9999	4011617784241	704010		21
ESIN0014	2CPX078425R9999	4011617784258	704010		21
ESIN0016	2CPX078426R9999	4011617784265	704010		21
ESIN0018	2CPX078427R9999	4011617784272	704010		21
ESIN0020	2CPX078428R9999	4011617784289	704010		21
ESPG0300	2CPX078145R9999	4011617781455	905010		19
ESPG0600	2CPX078146R9999	4011617781462	905010		19
ESPG0800	2CPX078147R9999	4011617781479	905010		19
ESPL0300	2CPX078148R9999	4011617781486	905010		19
ESPL0600	2CPX078149R9999	4011617781493	905010		19
ESPL0800	2CPX078150R9999	4011617781509	905010		19
ESSG0004	2CPX078127R9999	4011617781271	903010		20
ESSG0006	2CPX078128R9999	4011617781288	903010		20
ESSG0008	2CPX078129R9999	4011617781295	903010		20
ESSG0010	2CPX078130R9999	4011617781301	903010		20
ESSG0012	2CPX078131R9999	4011617781318	903010		20
ESSG0014	2CPX078132R9999	4011617781325	904010		20
ESSG0016	2CPX078133R9999	4011617781332	904010		20
ESSG0018	2CPX078134R9999	4011617781349	904010		20
ESSG0020	2CPX078135R9999	4011617781356	904010		20
ESSL0004	2CPX078136R9999	4011617781363	903010		20
ESSL0006	2CPX078137R9999	4011617781370	903010		20
ESSL0008	2CPX078138R9999	4011617781387	903010		20
ESSL0010	2CPX078139R9999	4011617781394	903010		20
ESSL0012	2CPX078140R9999	4011617781400	903010		20
ESSL0014	2CPX078141R9999	4011617781417	904010		20
ESSL0016	2CPX078142R9999	4011617781424	904010		20

Type	Ord. No.	EAN Code	Product-code	Price	Page
ESSL0018	2CPX078143R9999	4011617781431	904010		20
ESSL0020	2CPX078144R9999	4011617781448	904010		20
ESUG0004	2CPX078223R9999	4011617782230	906010		20
ESUG0006	2CPX078224R9999	4011617782247	906010		20
ESUG0008	2CPX078225R9999	4011617782254	906010		20
ESUG0010	2CPX078226R9999	4011617782261	906010		20
ESUG0012	2CPX078227R9999	4011617782278	906010		20
ESUG0014	2CPX078228R9999	4011617782285	906010		20
ESUG0016	2CPX078229R9999	4011617782292	906010		20
ESUG0018	2CPX078230R9999	4011617782308	906010		20
ESUG0020	2CPX078231R9999	4011617782315	906010		20
ESUL0004	2CPX078232R9999	4011617782322	906010		20
ESUL0006	2CPX078233R9999	4011617782339	906010		20
ESUL0008	2CPX078234R9999	4011617782346	906010		20
ESUL0010	2CPX078235R9999	4011617782353	906010		20
ESUL0012	2CPX078236R9999	4011617782360	906010		20
ESUL0014	2CPX078237R9999	4011617782377	906010		20
ESUL0016	2CPX078238R9999	4011617782384	906010		20
ESUL0018	2CPX078239R9999	4011617782391	906010		20
ESUL0020	2CPX078240R9999	4011617782407	906010		20
RM28	2CPX045910R9999	4011617459101	713020		21
RM38	2CPX045911R9999	4011617459118	713020		21
TZ101	2CPX010450R9999	4011617104506	704010		24
TZ101P10	2CPX010451R9999	4011617104513	704010		24
TZ101P100	2CPX010826R9999	4011617108269	704010		24
TZ102	2CPX010452R9999	4011617104520	704010		24
TZ102P10	2CPX010453R9999	4011617104537	704010		24
TZ103	2CPX010454R9999	4011617104544	704010		24
TZ103P10	2CPX010455R9999	4011617104551	704010		24
TZ104	2CPX010456R9999	4011617104568	704010		24
TZ105	2CPX010457R9999	4011617104575	704010		24
TZ106	2CPX010458R9999	4011617104582	704010		24
TZ106P10	2CPX010459R9999	4011617104599	704010		24
TZ107	2CPX010460R9999	4011617104605	704010		24
TZ107P10	2CPX010461R9999	4011617104612	704010		24
TZ110	2CPX010850R9999	4011617108504	704010		24
TZ111	2CPX010851R9999	4011617108511	704010		24
TZ112	2CPX010852R9999	4011617108528	704010		24
TZ501	2CPX010485R9999	4011617104858	704010		27
TZ511	2CPX010495R9999	4011617104957	704010		27
TZ517	2CPX010926R9999	4011617109266	704010		26
TZ518	2CPX010927R9999	4011617109273	704010		26
TZ601	2CPX010779R9999	4011617107798	704010		28
TZ604	2CPX010782R9999	4011617107828	704010		28
TZ605	2CPX010783R9999	4011617107835	704010		28
TZ626	2CPX010778R9999	4011617107781	704010		28
TZ628P10	2CPX010854R9999	4011617108542	701010		28
TZ637	2CPX078414R9999	4011617784142	704010		28
TZM204	2CPX010598R9999	4011617105985	704020		21
TZM208	2CPX010602R9999	4011617106029	704020		21
TZM304	2CPX010605R9999	4011617106050	704020		21
TZM308	2CPX010609R9999	4011617106098	704020		21
ZA116	2CPX039042R9999	4011617390428	701010		29
ZA123	2CPX038471R9999	4011617384717	701010		29
ZA125	2CPX038472R9999	4011617384724	701010		29
ZA13	2CPX038233R9999	4011617382331	701010		29
ZA13P10	2CPX062381R9999	4011617623816	701010		29
ZA16	2CPX038235R9999	4011617382355	701010		29
ZA5	2CPX038228R9999	4011617382287	701010		29
ZA5P10	2CPX062382R9999	4011617623823	701010		29
ZA6	2CPX038227R9999	4011617382270	701010		29
ZA61P10	2CPX062375R9999	4011617623755	701010		29
ZA6P10	2CPX062380R9999	4011617623809	701010		29
ZH130	2CPX060490R9999	4011617604907	701010		26
ZH131	2CPX060491R9999	4011617604914	701010		26
ZH132	2CPX060492R9999	4011617604921	701010		26
ZH133	2CPX060493R9999	4011617604938	701010		26
ZH134	2CPX060494R9999	4011617604945	701010		26
ZH135	2CPX060495R9999	4011617604952	701010		26
ZH136	2CPX060496R9999	4011617604969	701010		26
ZH137	2CPX060497R9999	4011617604976	701010		26

Index

Type	Ord. No.	EAN Code	Product-code	Price	Page
ZH157	2CPX060657R9999	4011617606574	701010		27
ZH158	2CPX060658R9999	4011617606581	701010		27
ZH160	2CPX060660R9999	4011617606604	701010		27
ZH161	2CPX060661R9999	4011617606611	701010		27
ZH162	2CPX060662R9999	4011617606628	701010		27
ZH163	2CPX060663R9999	4011617606635	701010		27
ZH164	2CPX060664R9999	4011617606642	701010		27
ZH165	2CPX060665R9999	4011617606659	701010		27
ZH91	2CPX066091R9999	4011617660910	701010		27
ZL8	2CPX038001R9999	4011617380016	701010		29
05 067					65
05 069					65
05 087					65
05 089					65
05 167					65
05 169					65
05 187					65
05 189					65
AD1004					66
AD1006					66
AD1007					66
AD1027					66
AD1028					66
AD1029					66
AD1030					66
AD1031					66
AD1056					61
AD1064					61
AD1065					61
AD1068					61
AD1075					66
AD1076					66
AD1077					61
AD1080					66
AD1081					66
AD1083					66
AP6000					55
BA0400					62
BA0800					62
BF1602					62
BF2502					62
BF4002					62
BF4012					62
BP0632					61
BR0250					62
BR0400					62
BR0630					62
ED0001					71
ED0003					71
ED0004					71
ED0025					69
ED0026					69
ED2183					70
ED2191					70
ED2209					70
ED2217					71
ED2225					71
ED2233					71
ED2241					71
ED2290					71
ED2308					71
ED2316					71
ED2324					71
ED2332					71
ED2340					71
ED2357					71
ED2365					71
ED2373					71
ED2373					71
ED2381					71
ED2407					71

Type	Ord. No.	EAN Code	Product-code	Price	Page
ED2531					70
ED2549					70
ED2551					70
ED2552					70
ED2553					70
ED2554					70
ED2556					70
ED2557					70
ED2557					70
ED2558					70
ED2559					70
ED2560					70
ED2564					70
ED2572					70
ED2590					70
ED2598					70
ED2606					70
ED2654					70
ED2662					70
ED2670					70
ED2720					70
ED2738					70
ED2746					70
ED2753					70
ED2845					71
ED2852					71
ED2894					70
ED2902					70
ED2910					70
ED2928					70
ED2936					71
ED2944					69
ED2951					69
ED2961					69
ED2962					69
ED2969					69
ED2977					69
ED2985					69
ED2993					69
ED3009					69
ED3017					69
ED3025					69
ED3033					69
ED3041					69
ED3058					69
ED3066					69
ED3082					69
ED3090					69
ED3101					69
ED3102					69
ED3103					69
ED3104					69
ED3108					69
ED3116					69
ED3124					69
ED3132					69
ED3272					69
ED3280					69
ED3298					69
ED3355					69
ED3363					69
ED3371					69
ED3405					69
ED3413					69
ED3439					69
EV1119					62
EV1120					62
EV1121					62
TS4011					64
TS4012					64
TS4013					64

Contact us

ABB STRIEBEL & JOHN GmbH & Co. KG

Am Fuchsgraben 2-3

77880 Sasbach

Germany

Phone: +49 7841 609 0

Fax: +49 7841 609 545

E-Mail: info.desuj@de.abb.com

www.striebelundjohn.com

We reserve the right to make technical changes or modify the contents of this document without prior notice. With regard to purchase orders, the agreed particulars shall prevail. ABB STRIEBEL & JOHN does not accept any responsibility whatsoever for potential errors or possible lack of information in this document.

We reserve all rights in this document and in the subject matter and illustrations contained therein. Any reproduction, disclosure to third parties or utilization of its contents - in whole or in parts - is forbidden without prior written consent of ABB STRIEBEL & JOHN.

Copyright © 2016 ABB STRIEBEL & JOHN

All rights reserved

K-K0310-PDF-1/0/2016-V1 · 20PC 000 310 C0201