

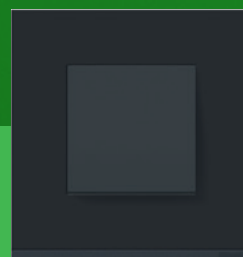

Unica

Catalogue 2019



schneider-electric.com

Life Is On

Schneider
Electric



General content

4	Presentation
44	Unica Inserts
58	Unica Inserts with Fixing Frame
68	Unica Wiser
74	Unica Fixing Frame Boxes & Cover Frame
82	Unica System+
86	Unica KNX
88	Unica Antibacterial
96	Unica Technical Informations
112	Unica Index

This guide contains clickable links for:

- page redirection towards table of contents or chapters,
- links to open web pages of the Schneider Electric site,
- links for videos.

Irresistibly Unica

We've taken the highly successful Unica design and given it a remarkable makeover. We found out just what electricians, designers and their customers wanted, and created new colors and materials to fit with any décor. New Unica features innovative functions to carry the range into the smart homes of the future. Welcome to the new Unica – irresistible, beautiful, and innovative.

Irresistibly beautiful new designs

Unica includes a suite of new designs, colors and materials. As well as standard white, there's now dark anthracite, soft beige, aluminium, plus a wide range of modern colors to suit any interior design beautifully. For the more design oriented, new Unica also includes textures of real glass, stone, wood and metals.

Irresistibly simple

Clever design innovation makes the Unica range easy to install – something any electrician will appreciate. We've thought of everything from modular installation and scalable solutions, to backwards compatibility with the original Unica range.

Irresistibly future-proof

Innovative and intuitive technology makes Unica a scalable range that offers Bluetooth capability, Wiser home automation and even KNX connectivity – so homes, offices and commercial buildings can now be future-ready.

Homes and commercial

Unica is designed to provide homes, offices and commercial buildings with one unified range. The perfect match for all installations.

Simplicity

Unica features ingenious design elements, so it's easy to install.

Irresistibly beautiful

Beautifully crafted with the latest and future trends in mind, the new Unica range is sure to turn heads in any home or commercial building.

Two beautiful new designs

The new Unica range includes two frame designs: Unica Studio and Unica Pure. Unica Studio comes in three formats: Studio, Studio Color, and Studio Metal. Unica Pure adds a touch of elegance with real materials: glass, stone, wood and metal.



Unica Studio

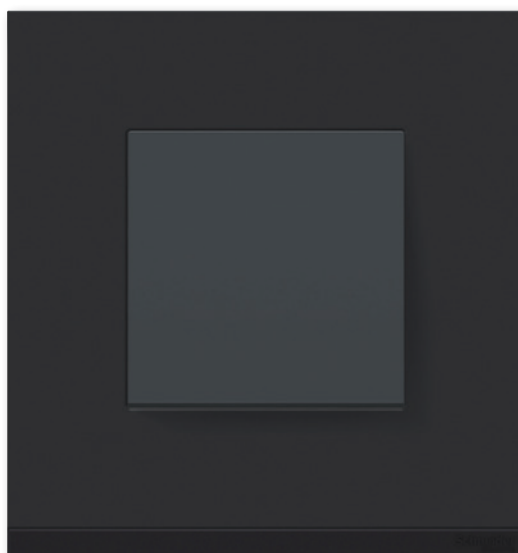

Unica Pure

Four insert colors

Unica allows you to combine each frame with the four insert colors available: white, beige, anthracite, and aluminium.



white

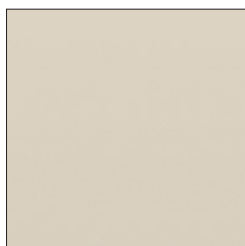

beige



anthracite

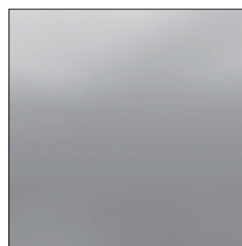

aluminium

Unica Studio

Unica Studio offers one modern shape, combined with three different material options, and numerous, modern and appealing colors and textures to satisfy every style and taste – Studio, Studio Color, and Studio Metal.

Timeless design

Unica Studio features a square frame with smooth, rounded corners and a large square switch. They are available in four classical colors: white, beige, anthracite, and aluminium. The balance of form and function is sublime with timeless design that blends perfectly with both modern and traditional interiors.

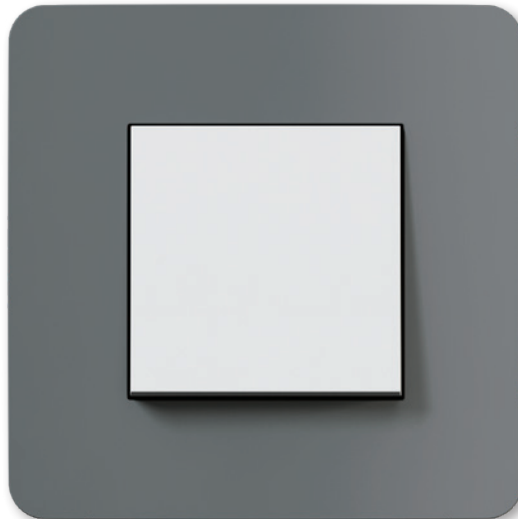

Perfect match

Unica comes in many color combinations to match any décor style.

Modern style

Let color define your customers' personalities. Bring life to living spaces with Unica Studio Color frames. Available in seven colors, there's a hue to match any décor and any furniture.

Elegant finishes

Unica Studio Metal offers elegant metal finishes in five exclusive colors for stylish environments and a discreet look. You can feel the quality through delicate textures and tones designed to bestow an air of sophistication in any setting.



Studio

The foundational range of Unica is Studio. White and beige are ideally suited to blend with lighter wall colors, while anthracite and aluminium are perfect accents for darker colors, creating warm, welcoming environments.



Unica Studio white



Unica Studio anthracite



Unica Studio aluminium



Unica Studio beige

Studio Color

Five soft colors match every interior from lighter, brighter shades to richer, cozy decor. Additionally, four bolder colors create lively accents in clean, welcoming interiors. With its modern shape and smooth, curved surface, Unica Color is the icing on the cake for fresh, clean interior design.

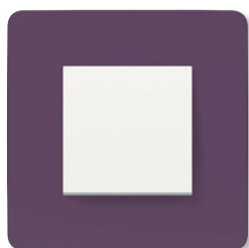

Unica Studio Color, plum

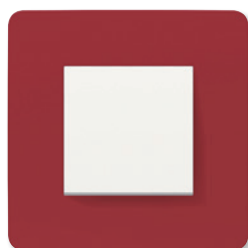

Unica Studio Color, red



Unica Studio Color, dark grey



Unica Studio Color, light green



Unica Studio Color, chocolate

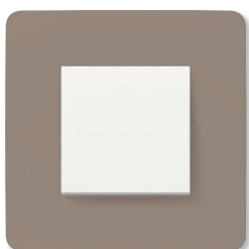

Unica Studio Color, taupe

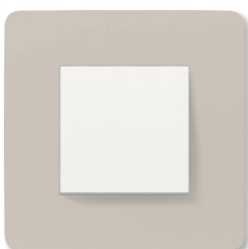

Unica Studio Color, light grey



Unica Studio Color, beige

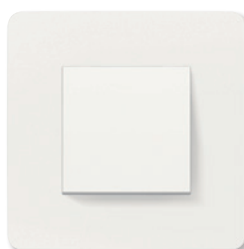

Unica Studio Color, white



Studio Metal

Touching Unica Studio Metal is a textural experience like no other. The range offers five ultra-modern and elegant finishes set to add an unmistakable charm to modern homes and office settings. The finely textured surface offers a new touch experience while preventing fingermarks.



Unica Studio Metal, bronze



Unica Studio Metal, dark aluminium



Unica Studio Metal, white aluminium

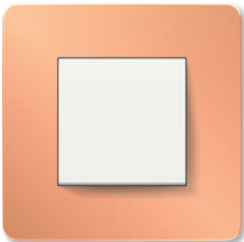

Unica Studio Metal, copper

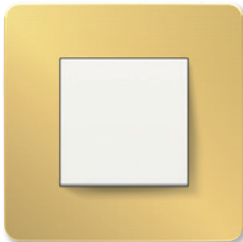

Unica Studio Metal, gold



Unica Pure

For sheer elegance, nothing comes close to the luxurious look and feel of Unica Pure. With a sleek, square design including faceplates made of real stone, wood, rubber, metal and glass, the range introduces a truly sophisticated feeling to quality interiors.

Rubber

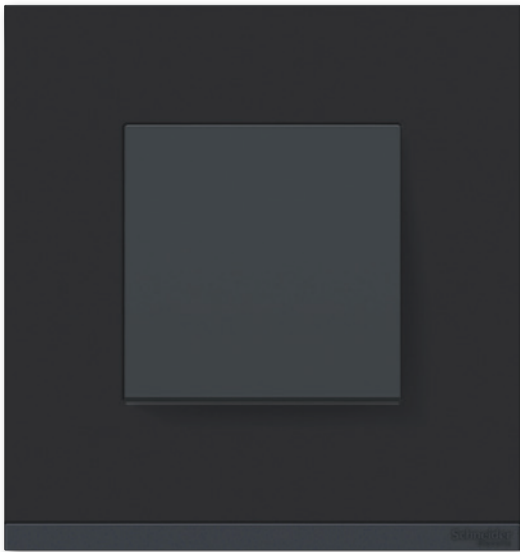

Unica Pure,
Rubber black

Stone



Unica Pure,
Stone slate



Wood

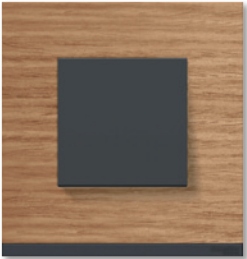

Unica Pure,
Wood oak



Unica Pure,
Wood nordic

Metal



Unica Pure,
Metal aluminium

Glass



Unica Pure,
Glass translucid white

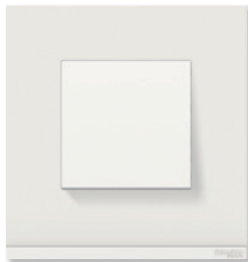

Unica Pure,
Glass frosted white

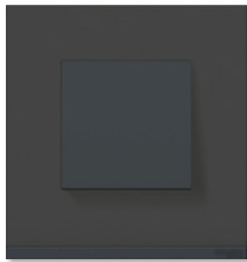

Unica Pure,
Glass frosted black





Irresistibly simple

The entire new Unica range has been designed to be simple and easy to install, with one offer for both homes and commercial applications. It is backwards compatible, and is infinitely scalable for easy planning and flexibility.

Easy installation

Unica features uniquely designed fixing frames, and modular switches and sockets to greatly simplify things for the electrician. The new design makes for simple, fast, and flexible installs. Easy-to-access release buttons, screwless socket-outlet terminals and extra space for wiring are just a few of the clever innovations. The modular approach offers a wide range of functions and new possibilities.

Easy clipping

The new size of Unica inserts allows for direct clipping to the trunking for even quicker and easier installation. This major simplification means one insert type can now be used for both homes and commercial buildings.

Backwards compatibility

Because Unica has long been a popular choice for homes and buildings throughout Europe, it was vitally important that the new range be backwards compatible. That's why we designed new Unica to easily integrate with legacy installations where necessary.

“

One of the most important features we instilled in Unica is ingenuity so the electrician could install more devices faster through simplicity of design.

”

Frédéric Beuvry
SVP Industrial Design & Ergonomics

Installation simplified

For electricians, efficiency is maximized with speed, ease, and flexible installation, which has everything to do with the simplicity of the system. That's why we designed Unica with clever features to be modular, very easy to understand, and super-quick to install.

Fixing frames

Flexible installation

Installation flexibility thanks to symmetric fixing frame sides.

Secure fixing

Finer tolerance between fixing frame and insert. Less dangling, the insert sits securely in the fixing frame.

Robust design

The new Unica fixing frame is bigger and more rigid due to the smaller 40 x 40 mm insert window. This provides extra strength to the frame to help prevent distortion from fastening the clips.

Perfect alignment

When you install two or more products in a multi-gang frame, it is important that the inserts are aligned. Unica's interlocking system avoids misalignment and slipping. Simple inserts and slots ensure perfect alignment every time.

Easy adjustment

The screw slots allow rotation of the insert in either direction to correct installation boxes that have been misaligned. These slots are a perfect fit for flush mounted box standard screws, so fixing is now even easier and even more secure.

Stronger connection

Finer tolerances between the fixing frame and cover create a stronger connection for a more reliable installation.

Intuitive design

Intuitive design of slots on the front and back of the fixing frame for screwdriver to remove the insert without marking the product. It also avoids injuries when the screwdriver is placed in the wrong position. Inserts can be removed easily from the front and back.

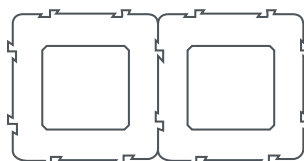
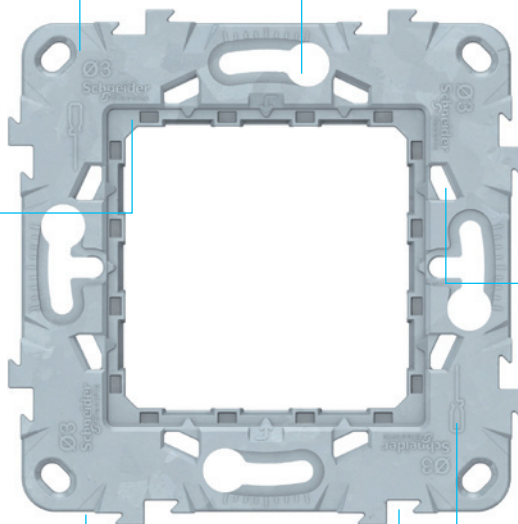

Protected handling

The claws are covered with a plastic part to avoid any harm during installation.



Robust fixing

The claw length has been increased for a better fixation in the box. When you hear a click sound, you know the claws are perfectly placed into the fixing frame.

Fixing frame options



Plastic fixing frame
2 modules



Plastic fixing frame
3 modules

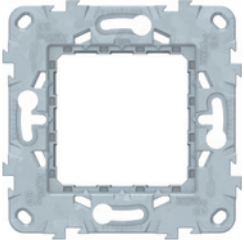

Zamak fixing frame
2 modules

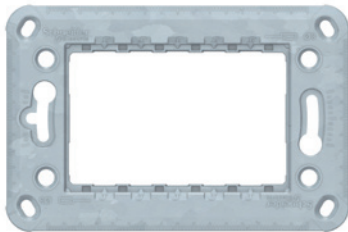

Zamak fixing frame
3 modules

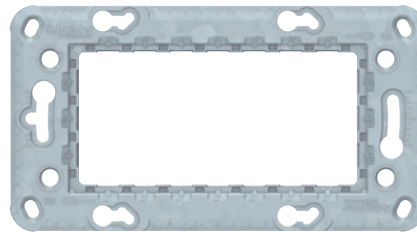

Zamak fixing frame
4 modules

Switch to smart design

Extra space

A low mounting depth of 21mm provides extra space for wiring.

Easy removal

Inserts can be removed from the front and back thanks to the clearly visible notches.



Robust clipping

The improved design of the clipping system secures the insert in the fixing frame.

Clear on/off status

The large rocker clearly indicates the status of the switch in the On and Off positions. When switched off, the rocker angle is now wider for increased separation of the contacts avoiding electrical arcs, contributing to make the switch more secure, and improving electrical performance.

Quick wiring

Prominent quick release buttons are easily accessible, making wiring quick and easy.

Simple connection

A wiring diagram is printed on the rear of the switch and push-button base to make connection options clearly visible.



Effortless wiring

Conical cable entries make it easier to feed the connection wires into the terminal blocks. Even thicker wires can be connected in less time thanks to the larger openings.

Covered cable entries

Cable entries that are not needed are covered, avoiding improper installation.



Easy indicator conversion

It's easy to convert any switch to a switch with an indicator lamp. Simply remove the standard rocker and add the accessory lamp and a rocker with a light window.

Convenient testing from the front

Unica switch and push-button inserts are designed to make installation easy, even for inserts that have already been installed. Checkpoints allow convenient testing of all functions and measuring from the front. Plus, there's no need to disassemble the switch – the rocker can easily be removed to access the checkpoints.

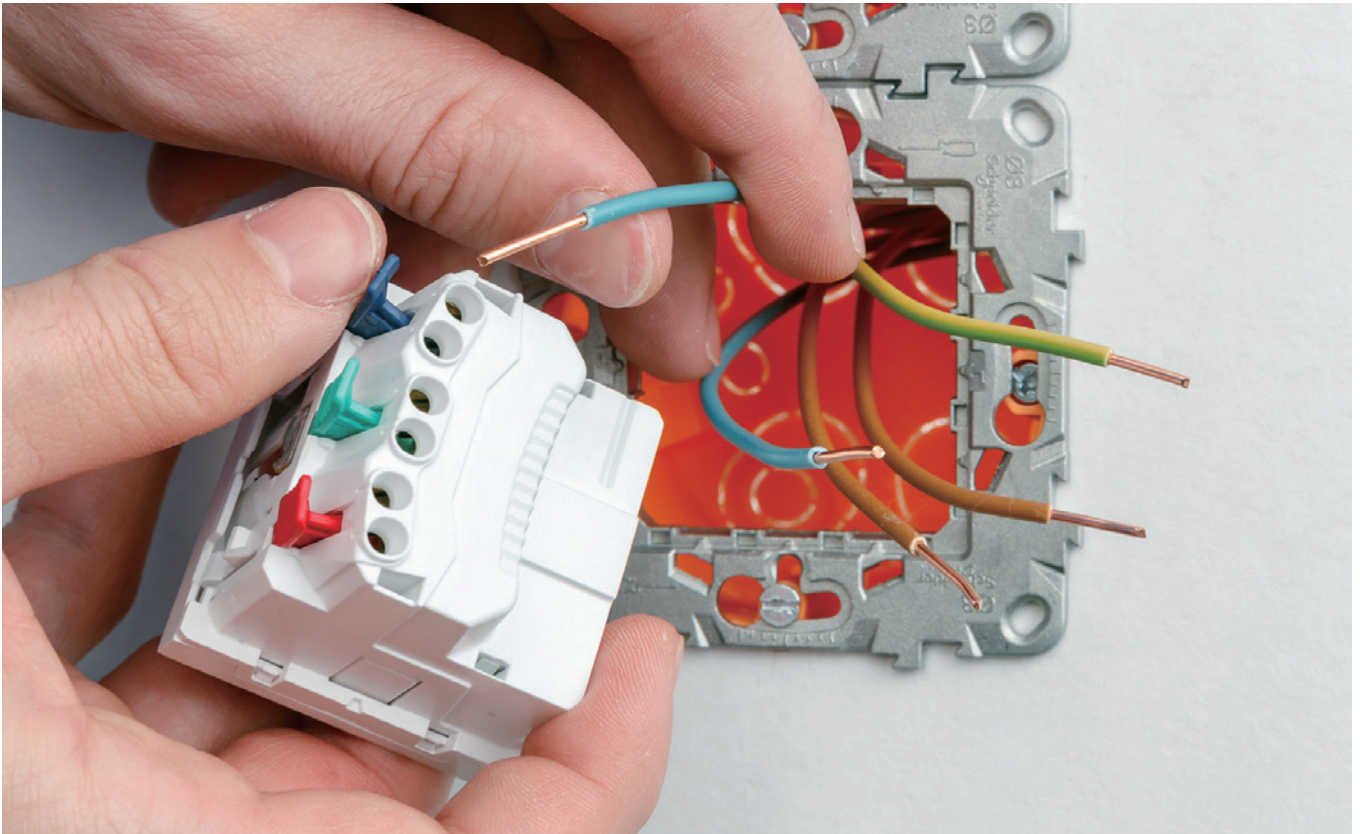

Special functions



One-way switch and push-buttons

For one-way switches and push-buttons, the phase and neutral cable entries are both on the top. This allows for simpler and faster wiring, without having to turn the insert to wire the other cable.

Slim insert

All white switch inserts come with a smaller housing, which offers more space for easy and fast wiring.



Intermediate switch

Having different colors for the two circuits makes it easy to distinguish between each for simpler and faster installations.

Push-button upgradable

All switch inserts with aluminium or anthracite rockers can be upgraded to a push-button due to the larger housing and push-button spring.

Switch to diversity

The new Unica range offers a wide choice of switches for every application, from standard light switches to pushbutton, roller blind, fan control, card switch, and more.



Switches and push-buttons

With a switch and pushbutton range including 16A or 20A, one-way or two-way, intermediate switch or two poles, with screw terminals or screwless, Unica offers the perfect switch for all applications.

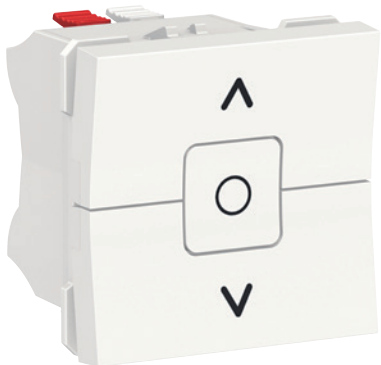

Roller blind switches

Unica roller blind switches feature an intuitively designed stop button in the center, with 'up' and 'down' in the corresponding rocker positions.



Card switches

Simplified from three to two modules, the Unica card switch offers compact size and greater flexibility. They can be simply installed the same way as other switches, with no need to remove the cover first.



Special switches



One-way key 3 position switch



Two-way switch fan control



Fan control switch on/off 2 speeds

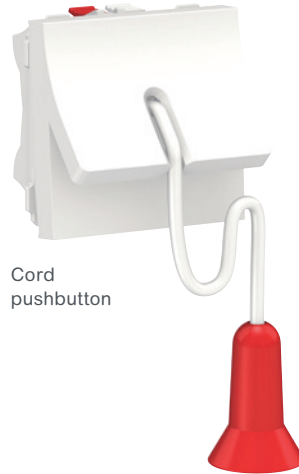

Cord pushbutton



Push-button with Bell



Push-button with light location lamp



Push-button with label holder



Sockets with screw terminals

Extra space

A low mounting depth of 21mm provides extra space for wiring.

Unclipped center plate

The center plate is unclipped, allowing easy removal for wiring.



Easy removal

Inserts can be removed from the front and back thanks to the clearly visible notches. The center plate can also be removed easily.

Shock protection

Integrated shutters protect against accidental contact and the ingress of foreign objects.

Large cable entries

Large cable entries allow wiring of 2,5mm² and 4mm² rigid and flexible cables.

Fast wiring

With the cable entries beside each other, you can cut all wires to the same length. The screws are positioned unfixed, so you don't have unscrew them before you start to wire the cables.

Improved protection

Cable entries are clearly separated, making wiring more intuitive and avoiding short-circuit risk when flexible wires are used.

Sockets with screwless terminals

Extra space

A low mounting depth of 21mm provides extra space for wiring.

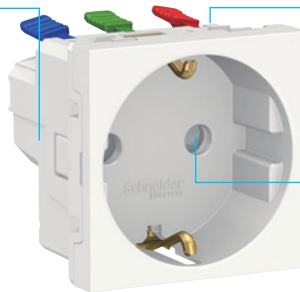

Easy removal

Inserts can be removed from the front and back thanks to the clearly visible notches. The center plate can also be removed easily.

Shock protection

Integrated shutters protect against accidental contact and the ingress of foreign objects.

Effortless wiring

Conical cable entries make it easier to feed the connection wires into the terminal blocks. Even thicker wires can be connected in less time thanks to the larger openings.



Quick wiring

Screwless socket-outlet terminals and color-coded quick release buttons making wiring quick and easy, without the need to remove the centre plate.

Special socket-outlets



Socket-outlet with lid, which can be opened up to 180°



Double socket-outlet

The new Unica range includes socket-outlets for every application including single, double and multi-gang outlets. They offer faster screwed and screwless options, with extra room and wider openings for quicker, simpler wiring.

Backwards compatibility

Because the original Unica was one of the most popular switch and socket-outlet ranges in Europe, we wanted the new Unica range to be fully backwards compatible.

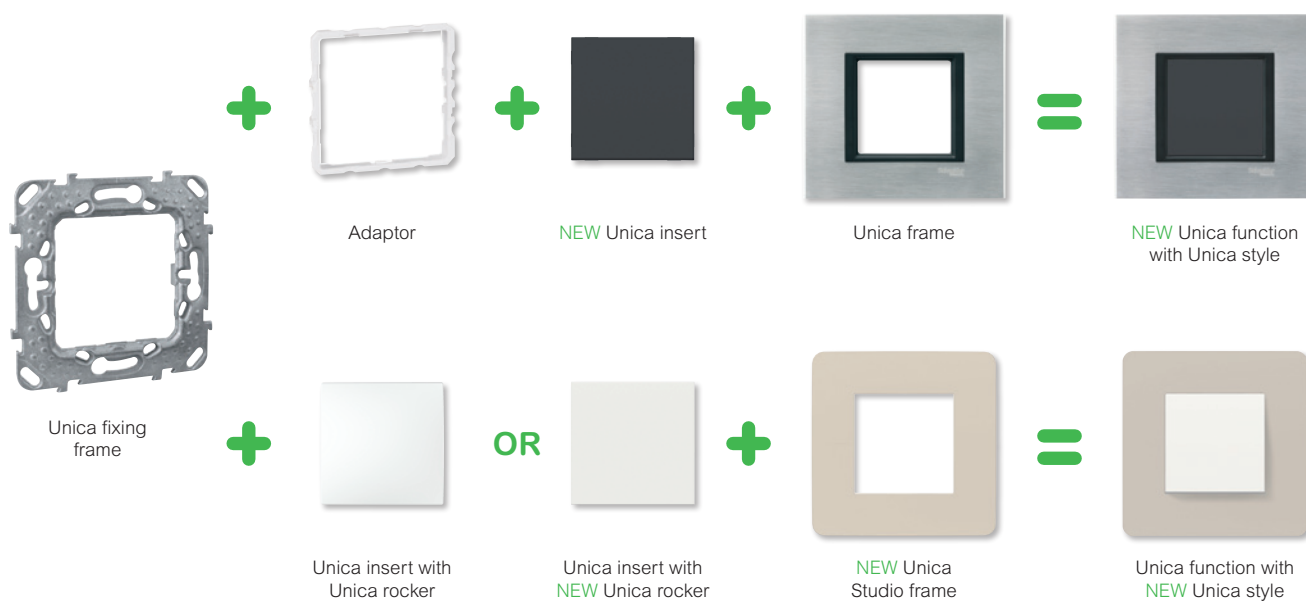



Unica accepts OptiLine 45 direct clipping

Unica facilitates faster installs through clever time-saving innovations. Because the range features 40mm x 40mm inserts, it accepts OptiLine 45 direct clipping to the trunking, poles and posts. There's no need to cut anything out or use adaptors – you just clip it into place.

One range for both applications

Unica allows for classical installations with wall boxes and trunking making the range uniquely simplified with no compromise on design. The switches installed on the wall box and the inserts clipped to the trunking are the same, creating a robust and flexible solution – no adaptors necessary.

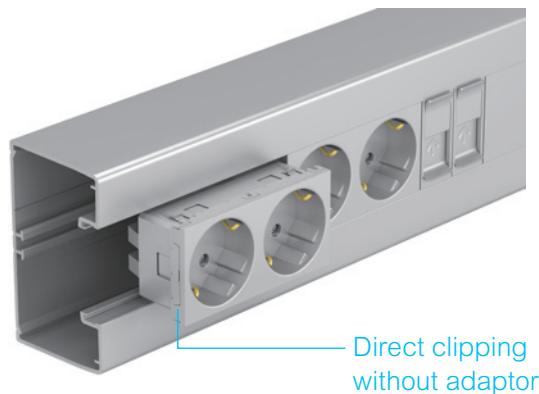

Direct clipping
without adaptor



Simply Unica System +

Unica inspires collaboration with System + workstations that are so modular, they can be easily configured to create any combination of inserts. System + is ideal for offices or other commercial buildings where several functions are needed in one place.

A range of sizes

The new Unica System + workstations come in many different sizes, including vertical and horizontal orientations for maximum flexibility. There are surface and flush-mounted boxes available. Boxes can be interlocked as required, and all are compatible with Schneider Electric mini-trunking.

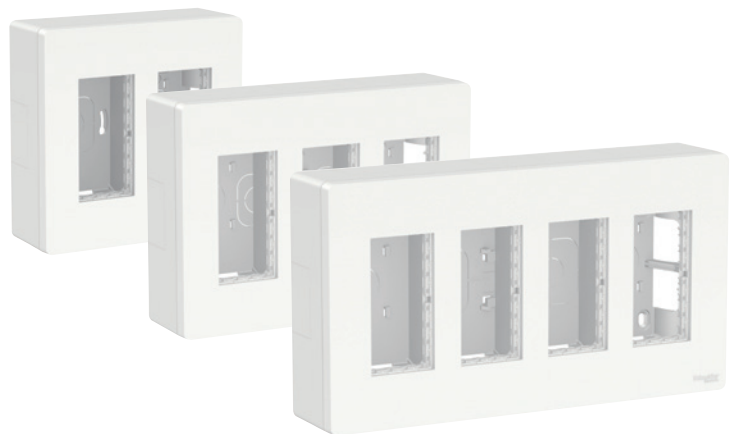

Choice of colors and kits

All boxes are available in white, aluminium and anthracite to match with Unica inserts. They are available as single components; complete with box, fixing frames, and covers; and as kits pre-equipped with the most common functions.



Workstation, white

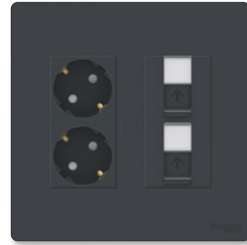

Workstation, anthracite



Workstation, aluminium

Surface

Flush

Vertical



Horizontal



Unica System + surface installation

Surface horizontal

Flush-mounted box compatibility

Workstations can be placed over a flush-mounted installation box instead of bringing the cables in via the mini-trunking. The box features entry holes for the cables.

Added security

Slide-in dividers keep power and data cables separated for added security. Dividers can be used for horizontal and vertical channels.

Faster installs

Unica System + comes with screws pre-mounted and unscrewed so you don't have to waste time removing them.

Flexible installation

Several entrances allow installation without the need to use a drill.

Easy adjustment

The mounting holes allow vertical and horizontal movement to balance boxes for perfect alignment every time.

Dual orientation

Screw towers allow the frames to be fixed in the horizontal position.

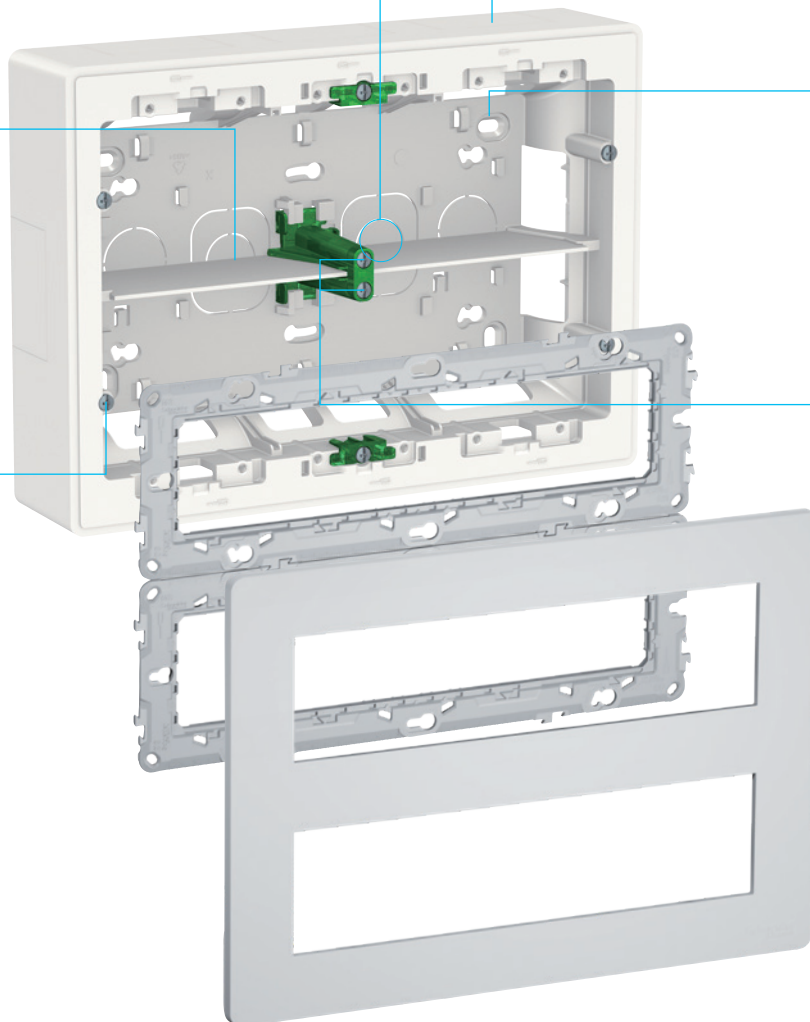

Mini-trunking compatible

Unica System + is compatible with Schneider Electric Mini-trunking.

Din Rail ready

The use of an adapter also allows Din Rail products such as Acti9 to be mounted.

Surface vertical

Added security

Slide-in dividers keep power and data cables separated for added security. Dividers can be used for horizontal and vertical channels.

Flexible installation

Several entrances allow installation without the need to use a drill. The screw tower can be installed both vertically and horizontally for more flexibility.

Faster installs

Unica System + comes with screws pre-mounted and unscrewed so you don't have to waste time removing them.

Easy adjustment

The mounting holes allow vertical and horizontal movement to balance boxes for perfect alignment every time.

Easy fixing

The fixing frames can be clipped directly to the workstations, without the need for tools.

Flush-mounted box compatibility

Workstations can be placed over a flush-mounted installation box instead of bringing the cables in via the mini-trunking. The box features screen entry holes for the cables.

Flexible clipping

Small bars allow single inserts to be clipped in for even greater flexibility and simple removal. The bars allow any Unica insert to be fixed to the boxes.

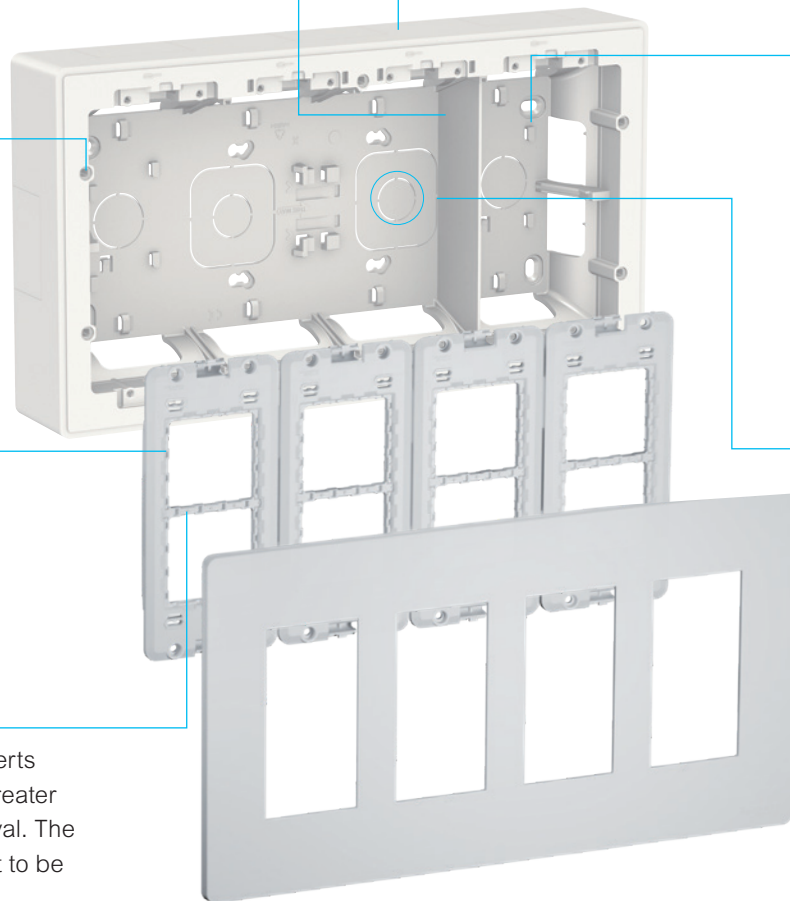

Connect multiple boxes

A small adaptor allows several boxes to be connected.

Unica System + flush installation

Flush horizontal

Increased rigidity

The boxes have been designed to be more rigid to make fixing to either vertical or horizontal frames much easier.

Added security

Slide-in dividers keep power and data cables separated for added security.

Dual orientation

The screw towers allow to fix the fixing frames in the horizontal installation.

Easier data cable installation

Box depth is now 50mm for easier installation of Cat6 and 6A data cables.

Holes for 20mm Ø tubes
Holes for 25mm Ø tubes

Easy drilling

Clear and wide holes to make sign on the wall for drilling.

Closed screws

Screws fully screwed in to avoid obstruction of holes with dust and other matter.

Broad flat frame

A broad and flat frame allows for perfect installation on the wall, even if it is uneven. The broad frame also stands proud of slightly larger holes to avoid "falling" into the hole.

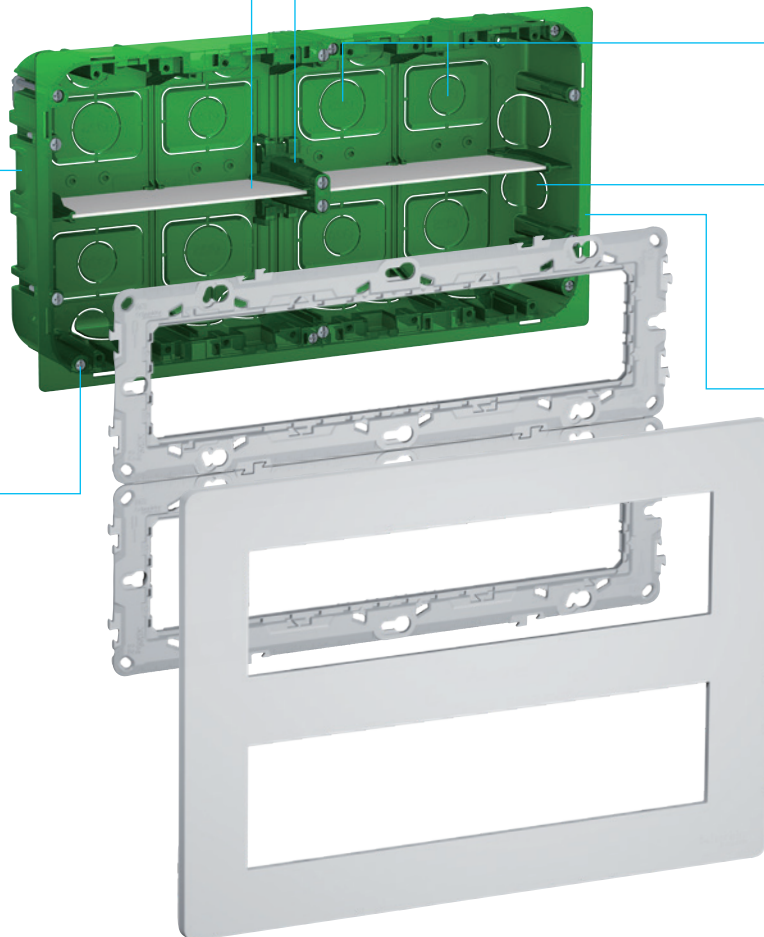

Flush vertical

Increased rigidity

The boxes have been design to be more rigid to make fixing to either vertical or horizontal frames much easier.

Easier data cable installation

Box depth is now 50mm for easier installation of Cat6 and 6A data cables.

Easy fixing

The fixing frames can be clipped directly to the workstations, without the need for tools.

Flexible clipping

Small bars allow single inserts to be clipped in for even greater flexibility and simple removal. The bars allow any Unica insert to be fixed to the boxes.

Added security

Slide-in dividers keep power and data cables separated for added security.

Holes for 20mm Ø tubes
Holes for 25mm Ø tubes

Easy drilling

Clear and wide holes to make sign on the wall for drilling.

Broad flat frame

A broad and flat frame allows for perfect installation on the wall, even if it is uneven. The broad frame also stands proud of slightly larger holes to avoid “falling” into the hole.

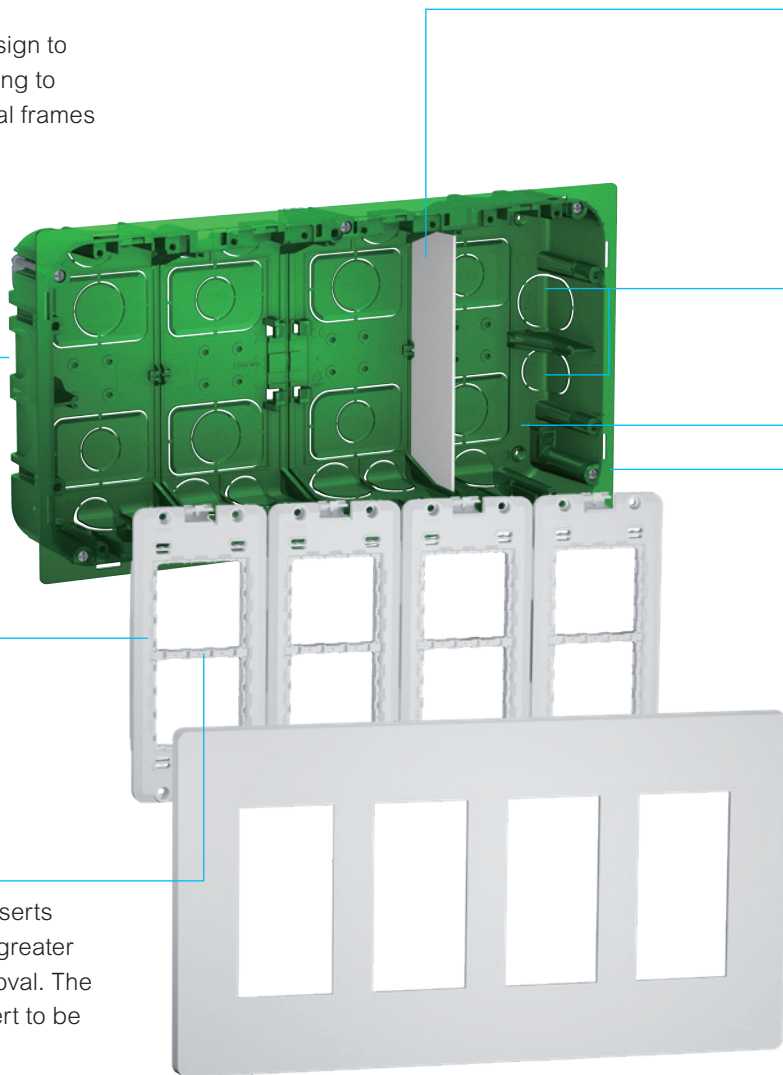

Simply efficient installation

Switch to simple efficiency on every install with new Unica System +. Clever features and design make the most used inserts – double sockets and RJ45 – fast and easy to install.

Double socket-outlet

Screw IPT terminal

The new Unica double socket-outlets feature insulated piercing terminals. You don't have to insulate the wires with a tool – you simply insert the wires, close the levers and the insulation happens automatically. Disassembling is also easy, and inserts can be used again.

Flexible cable sizes

1,5mm² and 2,5mm² rigid and flexible cables can be inserted.

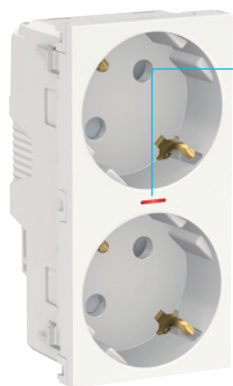

Indicator light

Double socket-outlets are also available with an indicator light.

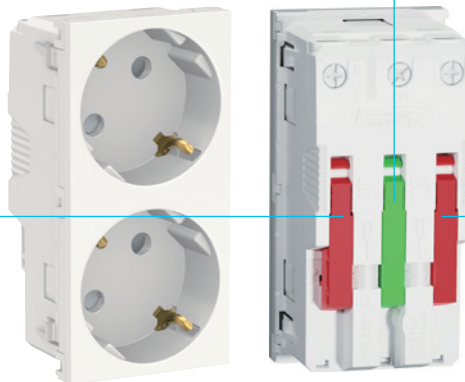

Screws on the back

There's no need to remove the center plate to screw – the center plate is simply clipped in.

Easy installation

The big levers can be opened up to 90°, which offers very easy access for wiring in, and removing cables.



RJ45

Time-saving installation

Unica offers several designs of RJ45 center plate. The double and quadruple versions are easy and fast to install. It also means you only need one device and less space for up to four connectors.

Convenient label holders

Used to identify the connected devices.



Protective shutters

Prevent ingress of dust and other objects when plug is not in use.

Total flexibility

The center plates can be used with any S1 Schneider Electric connector.

No adaptors needed

You can also clip inclined one or two module RJ45 connectors to the workstations. The bar on the fixing frame allows a secure fixing without the need for an adaptor.





Irresistibly future-proof

No matter what your customer is looking for, Unica has the right solutions, from standard electrical installations to fully connected systems. Scalable and future-proof, Unica is smart home-ready with a range of Wiser connected products.



Wiser smart home solutions

Wiser products leave nothing to be desired. Clever combined functions can be set up in either one product or a group of products to create special 'Moments' to suit your customers' preferences. You can also simply program and control Wiser products via the intuitive Wiser app.

Scalable home solutions with Wiser

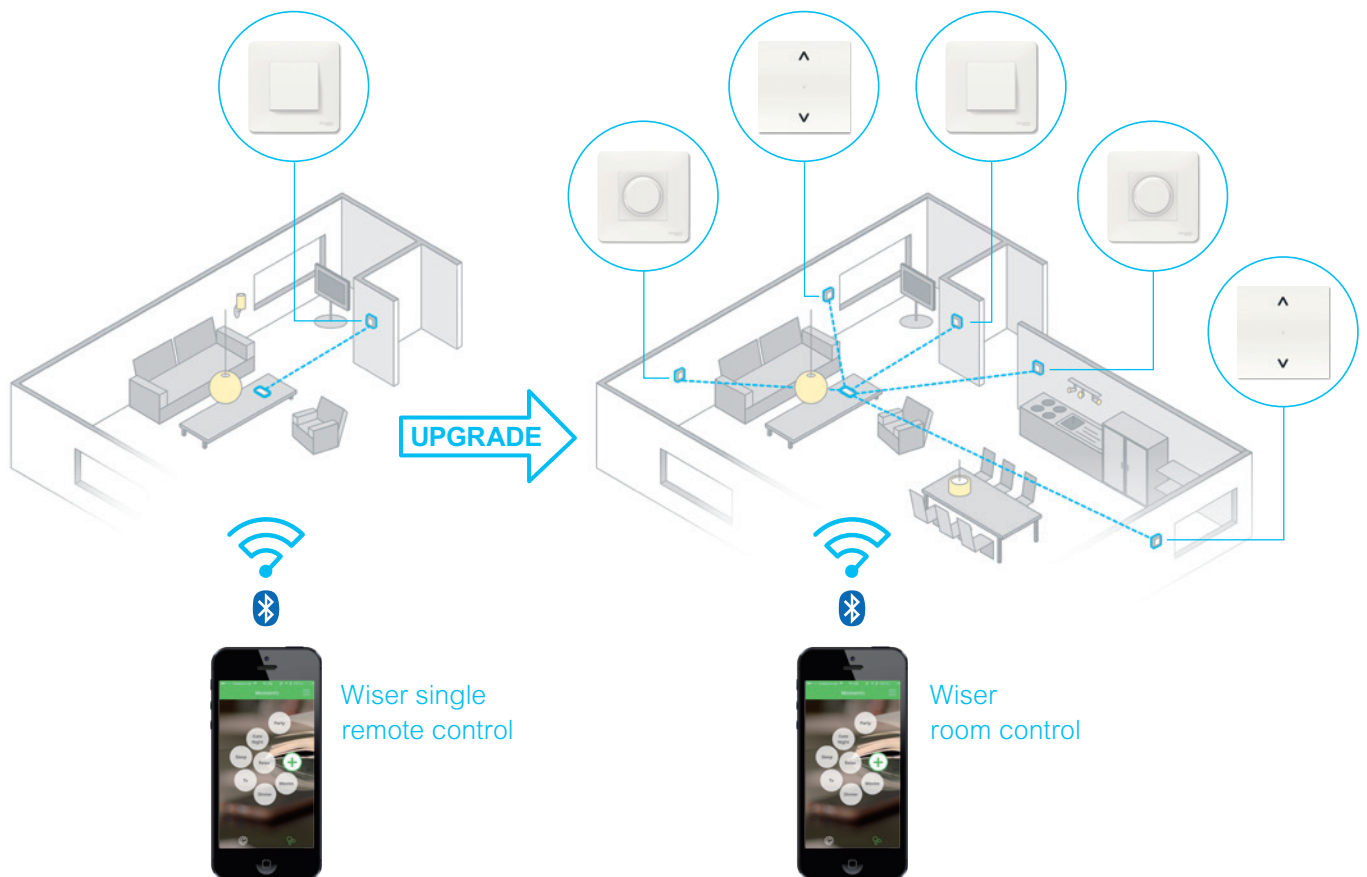

Create special 'Moments' for your customer...

Imagine being able to set the scene for your next dinner party with just the press of a button on your smartphone or tablet. How about being able to tap one button to set the mood for an action movie or romantic comedy? With Unica Wiser products and the Wiser app, making the most of every 'Moment' is easy.

Create 'Moments'

Functions you can group together for special 'Moments' are light settings and shutters. Your special 'Moments' might be the perfect setting for cooking, enjoying a meal, exercising, reading a book, or watching a movie or your favorite sport. 'Moments' can be created and activated with the app. Then in one tap, you're in the moment.

Start simple and grow

Setting up a smart home system is simple and scalable with Wiser connected products. You can start simply with a single smart product like a dimmer that you can control manually or via the Wiser app. Then later you can add more functions in a room and group them to create new 'Moments' as your smart home grows.

Easy Bluetooth connectivity

Unica Wiser products connect seamlessly to the Wiser app on your smartphone or tablet via hassle-free Bluetooth technology. Pairing a switch or timer is easy and allows you control its function from anywhere in the room.

Multitasking Wiser switches

Even a single Wiser switch can offer multitasking with different functions combined to provide smart solutions. For example, a dimmer is not just a dimmer; it can also be an alarm clock. It can even help children fall gently to sleep with the smart 'Fall asleep' function. Or, how about a motion sensor during the day, that becomes a night light at night?

Controlled via the app, Unica's multitasking Wiser products offer many new possibilities to create perfect 'Moments' for your customers.

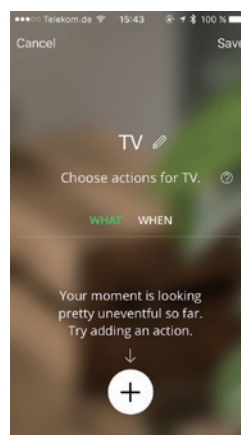

... and gain more moments for you

As well as being fast and easy to install, Unica Wiser products are designed to be super-easy to program with just a few taps on the app. All 'Moments' can be achieved easily and efficiently with Unica's simplified range, leaving more time for your own special 'Moments'.

Easy and fast programming

All settings and programming of single devices or 'Moments' can be done via the Wiser app.

More possibilities in one range

We've designed the new Unica Wiser range to cover all key functions in the home and commercial environments from only a select number of products. This makes it easier for you to offer more possibilities to your customers with one range.





Work smarter

Smartphones and tablets are not only used in your private life. They're also part of your working day. We developed the Wiser app so the new Unica Wiser devices would be super-easy to configure. You simply set everything up from your smart device.

Simple app set-up

The Wiser app has a simple, intuitive interface allowing you to program everything without the need for specialized training or tools. The app will guide you through the simple process.

Simplified programming & adjustment

Setting up and adjusting settings no longer requires removal of the insert to access Poti or Dip switches on the back, nor working on a small product display. You simply use the Wiser app on your smartphone or tablet. You can also make adjustments at any time via the app.

Easy set-up

The Wiser app can be programmed in three simple steps.
The app guides you through the process:

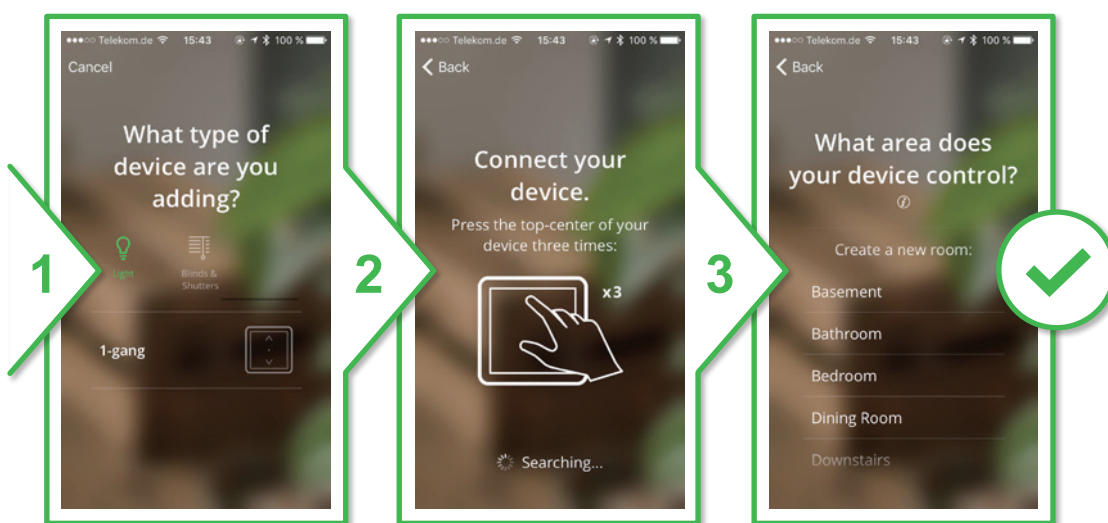

Step 1:
Select the device

Step 2:
Pair the device

Step 3:
Select the room



For smartphones and tablets:
The Wiser app is available for both Android and iOS devices.

Unica leaves nothing to be desired

The new Unica range features beautifully designed smart products that offer greater levels of comfort and style for homes and offices.

From creative lighting possibilities to connectivity and entertainment, Unica embraces current and future trends and applications.

Reduced energy costs

Unica thermostats can set a temperature and maintain it at a comfortable level as the outside temperature fluctuates, while also helping to reduce energy costs.



Simple shutter control

Manually controlling your shutters at the push of a button, or automatically via a time controller, Unica offers a greater level of convenience. Plus, your shutters protect your interiors from sun damage, and can even prevent burglary.



Lighting control

The range features rotary and push-button dimmers for a pleasant, light atmosphere optimized for both conventional and LED lighting. Automatic light control with movement detectors offers greater energy efficiency.



Socket-outlets

New Unica socket-outlets feature integrated child protection. Self-sealing shutters sit behind the electrode holes, which close when the plug is removed, reducing the chance of a child inserting anything into the holes. Unica socket-outlets are also available with IP44 protection against water and dust.



Connectivity

New Unica includes connectivity inserts for every socket type in the home or commercial application. "Intelligent" USB chargers allow smartphones and other devices to be charged directly to the socket, without the need for separate chargers. RJ45 sockets are for wired network connectivity, and HDMI sockets connect HDTV and AV components simply and neatly.



Commercial functionality

Designed to meet the diverse requirements of hotels, hospitals, offices and commercial buildings, Unica's special function products are the perfect answer.



All you need is Unica

Unica features clever products with smart functionality. You can easily set functions to suit your customers' preferences, and the range will grow with their requirements for a completely personalized, adaptable experience.

Living room

Moment 'Watch a movie' – the shutters go down; the lights go dim. Just the way you like for a perfect movie night. Roll it.

Moment 'Read a book' – the indirect lights dim, the spot at the couch switches on, and the shutters open. Feet up.

Kitchen

Moment 'Cooking' – the main lights and spots are switched to bright giving plenty of light to create the perfect meal. Bon appétit.

Moment 'Dinner party' – tonight's the night; the lights dim, selected spots switch on, and the garden lights complete the scene. Let's party.

Corridor

Automatic light control during the day

Unica includes a motion sensor light that doubles as a night light. During the day when movement is detected the light switches on, and off after a set period of time.

Smart night light function

Switch the dimmer function on to a lower level of brightness, e.g. 15 percent during the night, to help you move about safely.

Bedroom

Wake-up and fall asleep function

The Unica LED dimmer is ideal for the bedroom and all of your living spaces. Ease into sleep each night and wake up smoothly with lights that dim down, and then illuminate slowly to 100 percent at a set time. Think of them like a gentle alarm clock for a more pleasant way to start each day.

Automatic shutter control

Unica shutter control push-buttons allow you to open and close individual shutters or groups of shutters by setting your customer's preferences for open and shut times using the Wiser app.

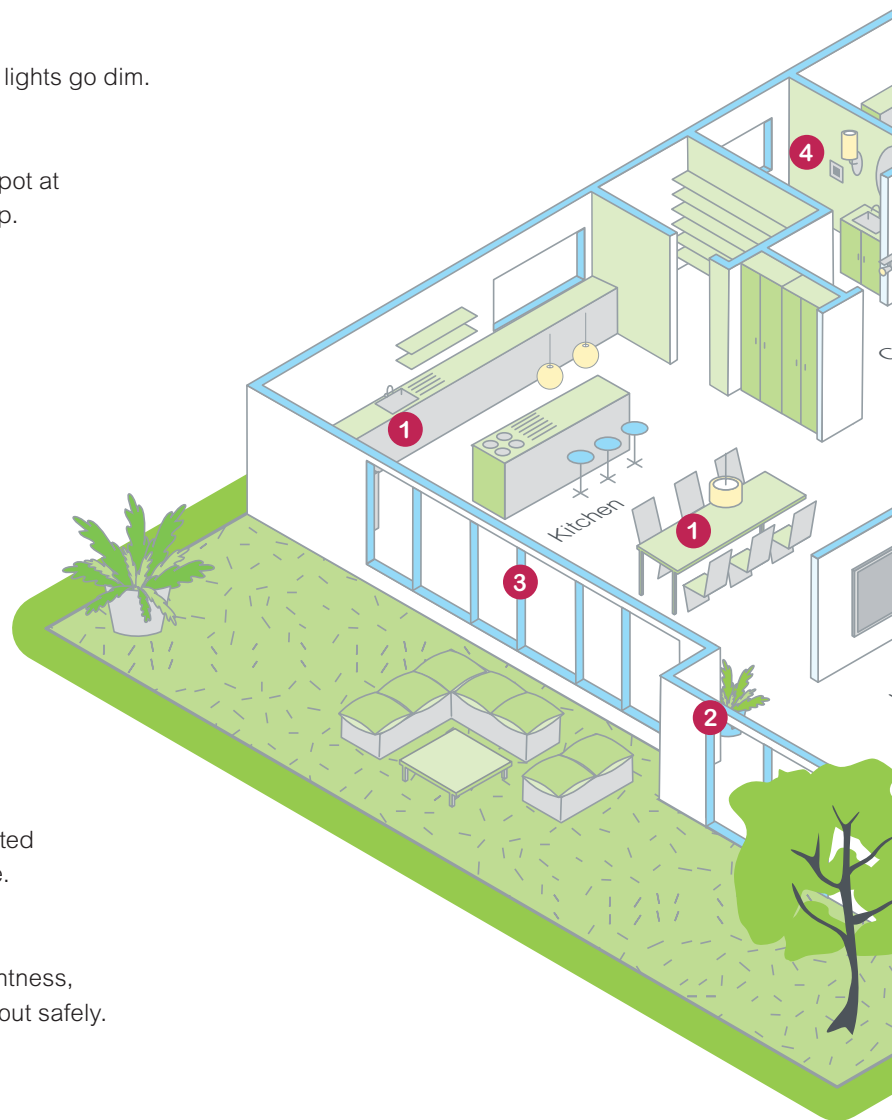



1 LED Rotary dimmer



2 Shutter control



3 Time control push-button



4 Automatic dimmer



5 Socket-outlets



6 USB chargers

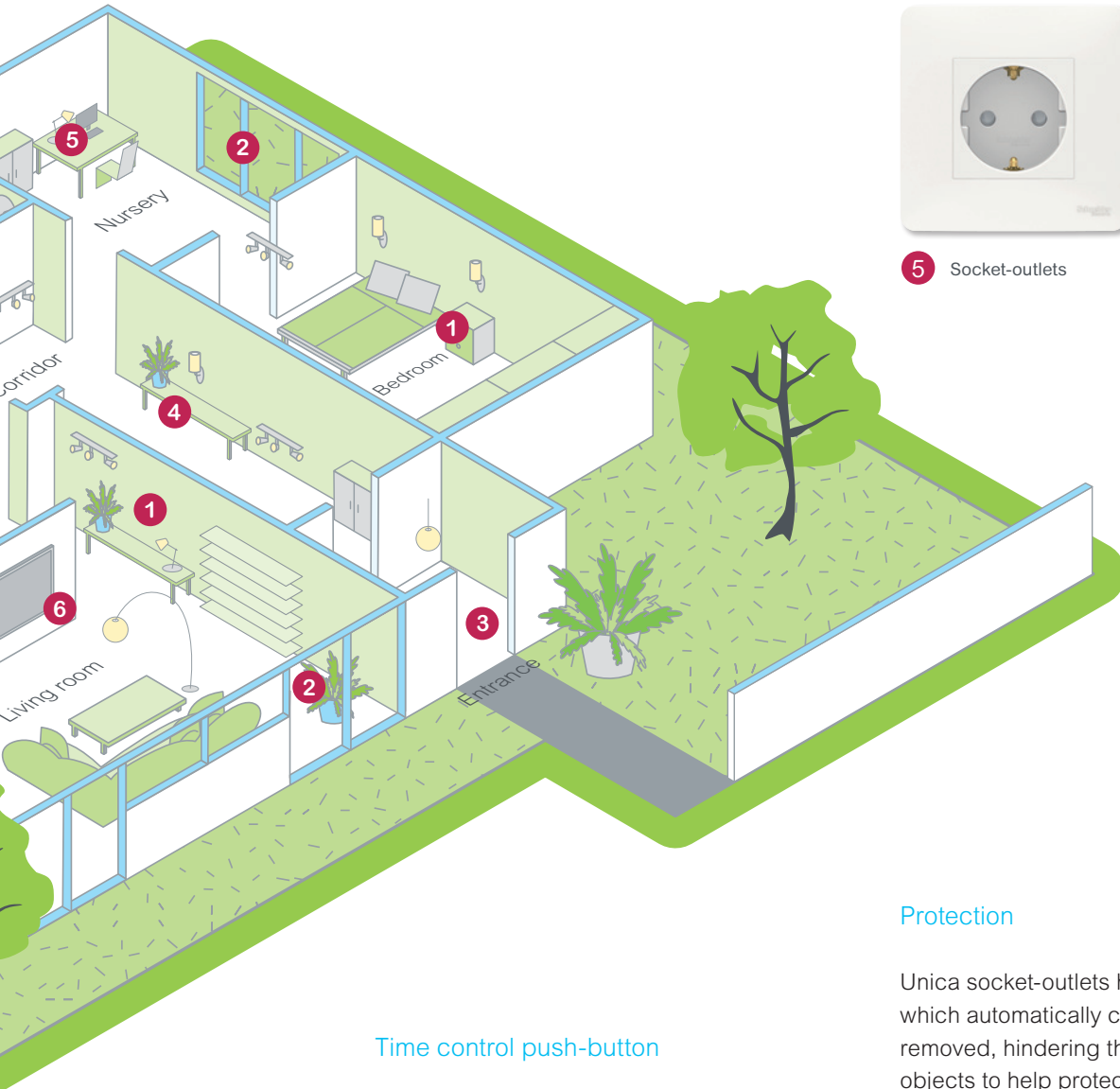

Time control push-button

To have your lights illuminated when you come home, simply enter your estimated arrival time. They can also be set to illuminate randomly each day while you're away, giving the illusion that someone is at home. Unica time control push-button switches also allow you to turn garden lights on and off automatically. Simply schedule via the app, and with the astro-clock function, times automatically track with seasonal changes.

Protection

Unica socket-outlets have integrated shutters which automatically close when a plug is removed, hindering the ingress of foreign objects to help protect children from electric shocks.

Connected

In a digital world it is more and more important to be connected 24/7. Unica offers a wide range of products like USB chargers for your tablets and smart phones, RJ45, HDMI connectors and much more.

Building control with KNX

KNX is the intelligent building control system for all living areas and workspaces, from single-family houses to office complexes and hotel facilities.

Unica offers all the KNX components required for connected, comfortable, and energy-efficient building control situations. They are easy to plan, install and operate. The familiar KNX system devices, actuators and sensors are now complemented by the new KNX Multitouch Pro; the new user interface that provides comprehensive functions and flexibility. They're easy to install and commission, saving you time and money.

Intuitive user interfaces

The KNX Multitouch Pro represents an entirely new generation of KNX user interfaces. It features intuitive controls, flexible functions and an aesthetically appealing design.

Innovative design

The new KNX Multitouch Pro features a harmonious, contact-sensitive touchscreen with a low mounting depth, so its placement in the frame is particularly flat. The display and the frame form a seamless unit with no protruding buttons. All functions are selected and directly controlled via the contact-sensitive touchscreen.

Flexible and individual

The unit offers a choice of two interface designs, with vertical or rotary arrangement, or a combination of both. The option to customize the screensaver individually is especially practical in the commercial sector. Whether in offices, hotels or the home – the KNX Multitouch Pro is an ideal contemporary solution wherever the emphasis is on design and functionality.

Integrated temperature sensor

The KNX Multitouch Pro has an integrated temperature sensor for connecting to a building's HVAC system, and can also be connected to a floor heating sensor.

Proximity sensor and gesture function

The proximity sensor illuminates the display when the user approaches. The gesture function allows you to control the most-used function with a simple hand gesture.



Intelligent operating philosophy

The KNX Multitouch Pro function control system is similar to that of a smartphone or tablet. Swiping is used for simple and intuitive switching between up to eight main screens. The main menu provides direct access to each function, e.g. temperature settings. Sub menus are accessed by tapping the screen.

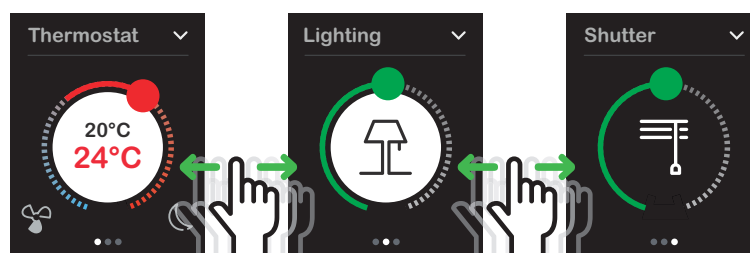

Installation and commissioning

The new KNX Multitouch Pro offers a completely new approach to planning, commissioning and installation. Simpler, faster and more flexible. In the past, all KNX functions had to be predefined before installation. Now the new KNX user interface makes planning simpler. An express commissioning feature enables rapid project design. The KNX Multitouch Pro does not require an additional power supply.

Unica Inserts

Content

46	Controls
48	Specialized controls
49	Comfort controls
50	Sockets
55	Indications
56	Complementary offer

10 AX - 250 V AC switches

	One-way	Two-way	Two-way with neutral terminal	Intermediate	Double one-way	Double two-way
2 modules						
<input type="checkbox"/> white	NU320118	NU320318 ⁽¹⁾ NU320318F ⁽²⁾	NU320318S	NU320518	NU321118	NU321318 ⁽¹⁾ NU321318F ⁽²⁾
<input type="checkbox"/> aluminium	NU320130	NU320330	NU320330S	NU320530	-	NU321330
<input checked="" type="checkbox"/> anthracite	NU320154	NU320354	NU320354S	NU320554	-	NU321354
1 module						
<input type="checkbox"/> white	NU310118	NU310318 ⁽¹⁾ NU310318F ⁽²⁾	NU310318S	NU310518		
<input type="checkbox"/> aluminium	NU310130	NU310330	NU310330S	NU310530		
<input checked="" type="checkbox"/> anthracite	NU310154	NU310354	NU310354S	NU310554		

Characteristics

- Connection: screwless terminals
- Cables: 1 to 2,5 mm² rigid/flexible
- Lightable with NU9825A, NU9823AM and NU9825AZ LED lamps and rockers with visor

(1) flow

(2) pack / box

16 AX - 250 V AC switches

	One-way	Two-way	2 poles	2 poles with indication lamp
2 modules				
<input type="checkbox"/> white	NU326118	NU326318	NU326218	NU326218S
<input type="checkbox"/> aluminium	-	NU326330	NU326230	NU326230S
<input checked="" type="checkbox"/> anthracite	-	NU326354	NU326254	NU326254S
1 module				
<input type="checkbox"/> white	NU316118	NU316318	NU316218	NU316218S
<input type="checkbox"/> aluminium	-	NU316330	-	-
<input checked="" type="checkbox"/> anthracite	-	NU316354	-	-











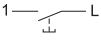
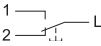
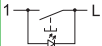



Characteristics

- Connection: screw terminals
- Cables: 1 to 2,5 mm² rigid/flexible
- Lightable with NU9825A, NU9823AM and NU9825AZ LED lamps and rockers with visor

20 AX - 250 V AC switches

	2 poles
2 modules	
<input type="checkbox"/> white	NU322518
Characteristics	
<ul style="list-style-type: none"> • Connection: screw terminals • Cables: up to 4 mm² rigid/flexible 	

10 A - 250 V AC push-buttons

	NO			NO/NC		NO with location lamp		
	without symbol	with bell symbol	with light symbol	without symbol	with label holder	without symbol	with bell symbol	with light symbol
								
2 modules								
								
<input type="checkbox"/> white	NU320618 ⁽¹⁾ NU320618F ⁽²⁾	NU320618C	NU320618L	NU323618	NU324620	NU320618N ⁽¹⁾ NU320618FN ⁽²⁾	NU320618CN	NU320618LN
<input type="checkbox"/> aluminium	NU320630	NU320630C	NU320630L	NU323630	NU324630	NU320630N	NU320630CN	NU320630LN
<input type="checkbox"/> anthracite	NU320654	NU320654C	NU320654L	NU323654	NU324654	NU320654N	NU320654CN	NU320654LN
1 module								
								
<input type="checkbox"/> white	NU310618 ⁽¹⁾ NU310618F ⁽²⁾	NU310618C	NU310618L	NU313618		NU310618N		
<input type="checkbox"/> aluminium	NU310630	NU310630C	NU310630L	NU313630		NU310630N		
<input type="checkbox"/> anthracite	NU310654	NU310654C	NU310654L	NU313654		NU310654N		







Characteristics



- Connection: screwless terminals
- Cables: 1.5 to 2.5 mm² rigid/flexible
- Lightable with NU9825A, NU9823AM and NU9825AZ LED lamps and rockers with visor

(1) flow

(2) pack / box

Accessories for switches and push-buttons

Rockers	without symbol	with visor	for Unica MGU ●●●●●
2 modules			
			
<input type="checkbox"/> white	NU920018	NU920018N	NU920018U
<input type="checkbox"/> aluminium	NU920030	NU920030N	NU920030U
<input type="checkbox"/> anthracite	NU920054	NU920054N	NU920054U
1 module			
			
<input type="checkbox"/> white	NU910018	NU910018N	NU910018U
<input type="checkbox"/> aluminium	NU910030	NU910030N	NU910030U
<input type="checkbox"/> anthracite	NU910054	NU910054N	NU910054U

LED lamps	12-24 V DC		250 V AC
	White	Red	White
			
	NU9823AM	NU9825A	NU9825AZ

Characteristics

Consumption	0.15 mA	1,5 mA	0,05 mA
-------------	---------	--------	---------

Spring to transform a switch to push-button





S520299



Characteristics

- 10 units delivered with a positioning aid tool

Fan controls

	Two-way 10 A	Two-way - On/Off - 10 A
2 modules		
		
<input type="checkbox"/> white	NU320320VMC	NU321418
<input type="checkbox"/> aluminium	NU320330VMC	NU321430
<input type="checkbox"/> anthracite	NU320354VMC	NU321454

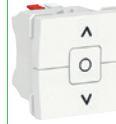

Roller blinds controls

	Push-button 6 A	10 A	Switch 6 A
2 modules			
			
<input type="checkbox"/> white	NU320718	NU323718	NU320818
<input type="checkbox"/> aluminium	NU320730	NU323730	NU320830
<input type="checkbox"/> anthracite	NU320754	NU323754	NU320854

Cord push-buttons

	NO/NC - 10 A
2 modules	
	
<input type="checkbox"/> white	NU322620
<input type="checkbox"/> aluminium	NU322630
<input type="checkbox"/> anthracite	NU322654

Key switches

	Push-button - 16 A	Switch - 16 A
2 modules		
		
<input type="checkbox"/> white	NU373118	NU370118
<input type="checkbox"/> aluminium	NU373130	-
<input type="checkbox"/> anthracite	NU373154	-
Characteristics		
<ul style="list-style-type: none"> • 3 positions 		





Card push-buttons

	NO/NC - 10 A
2 modules	
	
<input type="checkbox"/> white	NU328318
<input type="checkbox"/> aluminium	NU328330
<input type="checkbox"/> anthracite	NU328354



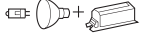
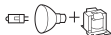

Emergency stop

	Key switch - 10 A	Mushroom - 10 A
2 modules		
		
<input type="checkbox"/> yellow	ALB45032	ALB45033



Dimmers

		Universal
2 modules		
		
<input type="checkbox"/> white		NU351418
<input type="checkbox"/> aluminium		NU351430
<input type="checkbox"/> anthracite		NU351454
Maximum loads		
LED lamp 230 V		RC: 5...100 VA RL: 5...20 VA
incandescent lamp 230 V		5...200 W
halogen lamp 230 V		5...150 W
LV halogen lamps 12 V	electronic transformer 	5...150 VA
	wound transformer 	5...150 VA
Characteristics		
<ul style="list-style-type: none"> • Remote control by unlimited number of auxiliary push-button • Automatic load detection • Wire configuration without neutral • Screw terminals connection • Memory function • Automatic overload protection, overheating protection, short-circuit protection 		

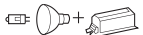
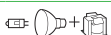
Motion sensors

		10 A
2 modules		
		
<input type="checkbox"/> white		NU352518
<input type="checkbox"/> aluminium		NU352530
<input type="checkbox"/> anthracite		NU352554
Maximum loads		
LED lamp 230 V		200 W
incandescent lamp 230 V		2200 W
halogen lamp 230 V		2000 W
motor (single-phase) 230 V		1000 VA
LV halogen lamps 12 V	electronic transformer 	1050 VA
	wound transformer 	500 VA
Characteristics		
<ul style="list-style-type: none"> • Screw terminals connection • Wire configuration with neutral • Detection angle: 160 ° • Movement detection area: 8 m frontal, 8 m lateral • Remote control by unlimited number of auxiliary push-button • Automatic load detection • Built-in on/off push-button switch • Time delay range: 1...30 min • Master/slave option; two sensors can be connected together to cover larger area 		

Thermostats

		Room - 8 A	Floor - 10 A
2 modules			
			
<input type="checkbox"/> white		NU350118	NU350318
<input type="checkbox"/> aluminium		NU350130	NU350330
<input type="checkbox"/> anthracite		NU350154	NU350354
Characteristics			
		<ul style="list-style-type: none"> • For heating or air-conditioning • Settings range: +5 to +30 °C • Blue and red LED's for conditioning or heating indication 	<ul style="list-style-type: none"> • For floor heating • Settings range: +5 to +45 °C • Green LED for voltage supply indication • Red LED for heating indication • Delivered with a 4 m temperature sensor

Timers

		Countdown timer relay - 10 A
2 modules		
		
<input type="checkbox"/> white		NU353518
<input type="checkbox"/> aluminium		NU353530
<input type="checkbox"/> anthracite		NU353554
Characteristics		
<ul style="list-style-type: none"> • Time delay range: 5 min to 8 h • Integrated status LED • 3-wires (neutral required) 		

French sockets-outlets

90°	Standard screwless	Standard screw	Surface screwless	Tamperproof screw
2 modules				
□ white	NU305918	NU303918 NU303918E ⁽¹⁾	NU305218	NU305118
■ aluminium	NU305930	NU303930	NU305230	-
■ anthracite	NU305954	NU303954	NU305254	-
■ red	NU305903	NU303903E ⁽¹⁾	NU305203	NU305103
■ green	NU305906	-	NU305206	-
■ orange	NU305961	-	-	-
Characteristics				
<ul style="list-style-type: none"> • 2P+E - 16 A - 250 V • With shutters 				

(1) For Spain

Double with cover frame	
□ white	NU406918
■ aluminium	NU406930
■ anthracite	NU406954
Characteristics	
<ul style="list-style-type: none"> • 2P - 16 A - 250 V • Screw terminals • With shutters • Installation in 1 gang box 	

45°	Standard			With lamp	Tamperproof		Tamperproof with lamp
	2 modules	4 modules	6 modules	4 modules	4 modules	6 modules	4 modules
□ white	NU304918	NU306918	NU307918	NU306918S NU306918SE ⁽¹⁾	-	-	-
■ aluminium	NU304930	NU306930	NU307930	NU306930S	-	-	-
■ anthracite	NU304954	NU306954	NU307954	NU306954S	-	-	-
■ red	NU304903	NU306903	NU307903	NU306903S NU306903SE ⁽¹⁾	NU306103	NU307103	NU306103S
■ green	NU304906	NU306906	NU307906	-	-	-	-
Characteristics							
<ul style="list-style-type: none"> • 2P+E - 16 A - 250 V • Screwless terminals • With shutters 							

(1) For Spain

French sockets-outlets for trunking

	90°	45°			Surface	Tamperproof		
	2 modules	2 modules	4 modules	6 modules	2 modules	2 modules	4 modules	6 modules
□ white	NU305920T	NU304918T	NU306918T	NU307918T	NU305218T	-	-	-
■ red	NU305903T	NU304903T	NU306903T	NU307903T	NU305203T	NU305103T	NU306103T	NU307103T
Characteristics								
<ul style="list-style-type: none"> • 2P+E - 16 A - 250 V • With shutters • Screwless terminals (except NU305103T) 								

German sockets-outlets

90°	With shutters screwless	With shutters screw	Without shutters screw	With lid & shutters screw	IP44 frame with shutters
2 modules					
<input type="checkbox"/> white	NU305718	NU303718	NU303618	NU303718TA	NU003718
<input type="checkbox"/> aluminium	NU305730	NU303730	-	NU303730TA	-
<input type="checkbox"/> beige	-	-	-	-	NU003744
<input type="checkbox"/> anthracite	NU305754	NU303754	-	NU303754TA	-
<input type="checkbox"/> red	NU305703	NU303703	-	-	-
<input type="checkbox"/> green	-	NU305706	-	-	-
Characteristics					
<ul style="list-style-type: none"> • 2P+E - 16 A - 250 V 					

Centres plates	
2 modules	
<input type="checkbox"/> white	NU903718
<input type="checkbox"/> aluminium	NU903730
<input type="checkbox"/> anthracite	NU903754
For Unica MGU.....	
2 modules	
<input type="checkbox"/> white	NU903718U
<input type="checkbox"/> aluminium	NU903730U
<input type="checkbox"/> anthracite	NU903754U

45°	Standard	With lamp
4 modules		
<input type="checkbox"/> white	NU306718A NU306718 (1)	NU306718AS NU306718S (1)
<input type="checkbox"/> aluminium	NU306730A	NU306730AS
<input type="checkbox"/> anthracite	NU306754A	NU306754AS
<input type="checkbox"/> red	NU306703A NU306703 (1)	NU306703AS NU306703S (1)
<input type="checkbox"/> green	-	NU306706AS
<input type="checkbox"/> orange	-	NU306761AS
Characteristics		
<ul style="list-style-type: none"> • 2P+E - 16 A - 250 V • Screw-IPT terminals (except (1): screw terminals in one side) • With shutters 		

	Simple with cover frame	Double with cover frame
<input type="checkbox"/> white	NU203718	NU206718
<input type="checkbox"/> aluminium	-	NU206730
<input type="checkbox"/> beige	-	NU206744
<input type="checkbox"/> anthracite	-	NU206754
Characteristics		
<ul style="list-style-type: none"> • Screw terminals • Installation in 1 gang box 		

European sockets-outlets

Simple	16 A	10 A
2 modules		1 modules
<input type="checkbox"/> white	NU303318	NU303118
<input type="checkbox"/> aluminium	NU303330	NU303130
<input type="checkbox"/> anthracite	NU303354	NU303154
Characteristics		
<ul style="list-style-type: none"> • 2P - 250 V • Screw terminals 		

Double with cover frame	
<input type="checkbox"/> white	NU206318
<input type="checkbox"/> beige	NU206344
Characteristics	
<ul style="list-style-type: none"> • 2P - 16 A - 250 V • Screw terminals • Installation in 1 gang box 	

Accessories

Jumper for french sockets-outlets	Tamperproof accessory	Red LED lamp
NU9091	ALB45290	NU9830
Characteristics		
<ul style="list-style-type: none"> • Set of 10 jumpers for multiple french screwless sockets-outlets 		<ul style="list-style-type: none"> • Plug & play

RJ45 data sockets

	Cat. 5e UTP straight	Cat. 5e STP straight	Cat. 6 UTP straight	Cat. 6 STP straight	inclined	Cat. 6 FTP straight	Cat. 6A UTP straight	Cat. 6A FTP straight
2 modules								
□ white	NU341118	NU341318	NU341518	NU341718	NU340718	NU341918		NU344918
■ aluminium	NU341130	NU341330	NU341530	NU341730	NU340730	NU341930		NU344930
■ anthracite	NU341154		NU341554	NU341754	NU340754	NU341954		NU344954
□ white	NU342018			NU342618				
■ aluminium	NU342030			NU342630				
■ anthracite	NU342054			NU342654				
1 module								
□ white	NU341018	NU341218	NU341418	NU341618	NU340618	NU344718		NU344818
■ aluminium	NU341030	NU341230	NU341430	NU341630	NU340630	NU344730		NU344830
■ anthracite	NU341054	-	NU341454	NU341654	NU340654	NU344754		NU344854
4 modules								
□ white	NU347818		NU348218				NU348418	
□ white	NU347918		NU348318				NU348518	
Characteristics								
<ul style="list-style-type: none"> • Connector Actassi S-One • Straight : with shutter and label space • Inclined : with label space 								

RJ45 centre plates

	For S-One RJ45 connector		For Keystone/Systimax RJ45 connector	
	straight	inclined	straight	inclined
2 modules				
□ white	NU941118	NU940718	NU946118	NU946418
■ aluminium	NU941130	NU940730	NU946130	NU946430
■ beige	NU941144	-	-	-
■ anthracite	NU941154	NU940754	NU946154	NU946454
□ white	NU942018			
■ aluminium	NU942030			
■ anthracite	NU942054			
1 module				
□ white	NU941018	NU940618	NU946018	
■ aluminium	NU941030	NU940630	NU946030	
■ beige	NU941044	-	NU946054	
■ anthracite	NU941054	NU940654		
4 modules				
□ white	NU947818		NU946218	
■ aluminium	NU947830		NU946230	
■ anthracite	NU947854		NU946254	
□ white	NU947918		NU946318	
■ aluminium	NU947930		NU946330	
■ anthracite	NU947954		NU946354	

Characteristics

- Straight : with shutter and label space
- Inclined : with label space

RJ45 centre plates for trunking

	For S-One RJ45 connector straight
2 modules	
□ white	NU941118T
Characteristics	
• With shutter and label space	







Optical fibre centre plates

	SC/SC APC Simplex	SC/SC APC duplex
2 modules		
□ white	NU943918	NU943818
■ aluminium	NU943930	NU943830
■ anthracite	NU943954	NU943854
Characteristics		
<ul style="list-style-type: none"> • Support to receive any SC simplex and duplex adapters • Support to receive Actassy optical fibre adapters: <ul style="list-style-type: none"> - SC Duplex multi mode adapters: ref. n° VDIB6031001 and VDIB6031002 - SC Duplex single mode adapters: ref. n° VDIB6032001 and VDIB6032002 - SC APC Duplex single mode adapter: ref. n° VDIB6082001 - SC APC Simplex single mode adapter: ref. n° VDIB6072001. 		

Telephone sockets

	RJ12 connector	French standard phone jack
2 modules		
□ white	NU349718	NU349618
■ aluminium	NU349730	NU349630
■ anthracite	NU349754	NU349654
1 module		
□ white	NU349118	-
■ aluminium	NU349130	-
■ anthracite	NU349154	-



Radio and television sockets

	TV		TV/FM			R-TV/SAT			FM/TV/SAT
	male, individual	female, individual	individual	intermediate	terminal	individual	intermediate	terminal	individual (1 cable)
2 modules									
									
<input type="checkbox"/> white	NU346218	-	NU345118	NU345318	NU345218	NU345418	NU345618	NU345518	NU345018
<input type="checkbox"/> aluminium	NU346230	-	NU345130	NU345330	NU345230	NU345430	NU345630	NU345530	NU345030
<input type="checkbox"/> anthracite	NU346254	-	NU345154	NU345354	NU345254	NU345454	NU345654	NU345554	NU345054
1 module									
									
<input type="checkbox"/> white	NU346118	NU346818	-			-			-
<input type="checkbox"/> aluminium	NU346130	NU346830	-			-			-
<input type="checkbox"/> anthracite	NU346154	NU346854	-			-			-



Multi service sockets

	M-S
2 modules	
	
<input type="checkbox"/> white	NU545718
<input type="checkbox"/> aluminium	NU545730
<input type="checkbox"/> anthracite	NU545754





Multimedia sockets

	VGA	Mini Jack	HDMI	RCA
1 module				
				
<input type="checkbox"/> white	NU343218	NU343318	NU343018	NU343118
<input type="checkbox"/> aluminium	NU343230	NU343330	NU343030	NU343130
<input type="checkbox"/> anthracite	NU343254	NU343354	NU343054	NU343154



Radio and television centre plates

	TV/FM	R-TV/SAT
2 modules		
		
<input type="checkbox"/> white	NU944018	NU944118
<input type="checkbox"/> aluminium	NU944030	NU944130
<input type="checkbox"/> beige	NU944044	-
<input type="checkbox"/> anthracite	NU944054	NU944154



USB data sockets and chargers

	Data sockets	Chargers type A	Chargers type A+C
2 modules			
			
<input type="checkbox"/> white	-	NU341818	NU301818
<input type="checkbox"/> aluminium	-	NU341830	NU301830
<input type="checkbox"/> anthracite	-	NU341854	NU301854
1 module			
			
<input type="checkbox"/> white	NU342918	NU342818	-
<input type="checkbox"/> aluminium	NU342930	NU342830	-
<input type="checkbox"/> anthracite	NU342954	NU342854	-
Characteristics			
	<ul style="list-style-type: none"> • USB 2.0 	<ul style="list-style-type: none"> • Output power: <ul style="list-style-type: none"> - NU3418●●: 5 V DC - max 2.1 A - NU3428●●: 5 V DC - 1 A 	<ul style="list-style-type: none"> • NU3018●●, output power: 5 V DC - max 2.4 A





Loudspeakers connectors

	2 modules	1 module
		
<input type="checkbox"/> white	NU348618	NU348718
<input type="checkbox"/> aluminium	NU348630	NU348730
<input type="checkbox"/> anthracite	NU348654	NU348754

Sound signaling

	Buzzer	Electronic doorbell
2 modules		
		
<input type="checkbox"/> white	NU378518	NU378618
<input type="checkbox"/> aluminium	NU378530	NU378630
<input type="checkbox"/> anthracite	NU378554	NU378654
Characteristics		
	<ul style="list-style-type: none"> • 230 V AC, 50/60 Hz • Acoustic level: adjustable from 76 to 80 dB/1 m 	<ul style="list-style-type: none"> • Acoustic level: 70 dB/1m • 5 melodies • Maximum connected in parallel to the output: <ul style="list-style-type: none"> - 10 without lamp - or 3 with lamp

Light signaling

Signaling light	
12-24 V DC	230 V AC
2 modules	
	
NU3773	NU3772
1 module	
	
NU3774	NU3775
<ul style="list-style-type: none"> • Delivered with green and red papers to include under the centre plate. 	



Emergency light
2 modules

NU3776
Characteristics
<ul style="list-style-type: none"> • 45 lux / 25 cm • Integrated battery • 230 V AC

Inserts

Complementary offer





Blind covers

	2 modules	1 module	1/2 module (2 x)
			
□ white	NU986618	NU986518	NU986418
■ aluminium	NU986630	NU986530	NU986430
■ anthracite	NU986654	NU986554	NU986454

Cable Outlets





16 A	
2 modules	
	
□ white	NU386218
■ aluminium	NU386230
■ anthracite	NU386254
Characteristics	
● cable diameter: from 6 to 12 mm	

IP55 cover and boxes

Box cover with lid	Boxes for surface mounting				
	1 gang	2 gangs, horizontal	2 gangs, vertical	3 gangs, horizontal	
					
□ white	MUR39110	MUR39911	MUR39914	MUR39912	MUR39913
■ anthracite	MUR35110	MUR37911	MUR37914	MUR37912	MUR37713
Characteristics					
	● IP55 ⁽¹⁾ - IK06	● IP55 ⁽²⁾ - IK08			

(1) when installed in a box or frame.
 (2) when completed with covers.

Frames for flush mounting

	1 gang	1 gang, with claws	2 gangs, horizontal	2 gangs, vertical	3 gangs, horizontal
					
□ white	MUR39107	MUR39108	MUR39101	MUR39151	MUR39109
■ anthracite	MUR34107	MUR34108	MUR34101	MUR34151	MUR34109
Characteristics					
	● IP55 ⁽²⁾ (on flat/smooth walls only. IP44 ⁽²⁾ if mounted on uneven walls with MUR34007 ref.) / IK08.				

(2) when completed with covers.

Accessories

Support for vertical installations	
2 modules	
	
□ white	NU9580
Characteristics	
● to install inserts in vertical trunking in right position	

Fuseholder

16 A	
1 module	
	
□ white	NU363118
■ aluminium	NU363130
■ anthracite	NU363154

Unica Inserts with Fixing Frame



Inserts with fixing frame

Controls

10 AX - 250 V AC switches

	Standard			With location lamp		
	one-way	two-way	intermediate	one-way	two-way	intermediate
2 modules						
<input type="checkbox"/> white	NU520118	NU520318	NU520518	NU520118N	NU520318N	NU520518N
<input type="checkbox"/> aluminium	NU520130	NU520330	NU520530	NU520130N	NU520330N	NU520530N
<input type="checkbox"/> beige	NU520144	NU520344	NU520544	NU520144N	NU520344N	NU520544N
<input type="checkbox"/> anthracite	NU520154	NU520354	NU520554	NU520154N	NU520354N	NU520554N
2 x 1 module						
<input type="checkbox"/> white	NU521118	NU521318	NU521518	NU521118N	NU521318N	
<input type="checkbox"/> aluminium	NU521130	NU521330	NU521530	NU521130N	NU521330N	
<input type="checkbox"/> beige	NU521144	NU521344	NU521544	NU521144N	NU521344N	
<input type="checkbox"/> anthracite	NU521154	NU521354	NU521554	NU521154N	NU521354N	

Characteristics

- Connection: screwless terminals
- Cables: 1 to 2,5 mm² rigid/flexible
- Lightable with NU9825A, NU9823AM and NU9825AZ LED lamps and rockers with visor

16 AX - 250 V AC switches

	Standard	With indication lamp
	2 poles	2 poles
2 modules		
<input type="checkbox"/> white	NU526218	NU526218S
<input type="checkbox"/> aluminium	NU526230	NU526230S
<input type="checkbox"/> beige	NU526244	NU526244S
<input type="checkbox"/> anthracite	NU526254	NU526254S

Characteristics

- Connection: screw terminals
- Cables: 1 to 2,5 mm² rigid/flexible
- Lightable with NU9825A, NU9823AM and NU9825AZ LED lamps and rockers with visor

Inserts with fixing frame

Controls

10 A - Push-buttons

	NO	NO with location lamp
2 modules		
□ white	NU520618	NU520618N
■ aluminium	NU520630	NU520630N
■ beige	NU520644	NU520644N
■ anthracite	NU520654	NU520654N
Characteristics		
<ul style="list-style-type: none"> • Connection: screwless terminals • Cables: 1.5 to 2.5 mm² rigid/flexible • Lighttable with NU9825A, NU9823AM and NU9825AZ LED lamps and rockers with visor 		

Accessories for switches and push-buttons

Rockers	without symbol	with visor	for Unica with MGUx.xxx.xx references
2 modules			
□ white	NU920018	NU920018N	NU920018U
■ aluminium	NU920030	NU920030N	NU920030U
■ anthracite	NU920054	NU920054N	NU920054U
1 module			
□ white	NU910018	NU910018N	NU910018U
■ aluminium	NU910030	NU910030N	NU910030U
■ anthracite	NU910054	NU910054N	NU910054U

LED lamps	12-24 V DC	250 V AC	
	white	red	white
	NU9823AM	NU9825A	NU9825AZ
Characteristics			
Consumption	0,15 mA	1,5 mA	0,05 mA

Spring to transform a switch to push-button



S520299

Characteristics

- 10 units delivered with a positioning aid tool

Inserts with fixing frame

Comfort controls

Doorbells

Electronic programmable	
2 modules	
	
<input type="checkbox"/> white	NU578618
<input type="checkbox"/> aluminium	NU578630
<input type="checkbox"/> beige	NU578644
<input type="checkbox"/> anthracite	NU578654
Characteristics	
<ul style="list-style-type: none"> • 230 V AC, 50/60 Hz • Acoustic level: 70 dB/1m • 5 melodies • Maximum connected in parallel to the output: <ul style="list-style-type: none"> - 10 without lamp - or 3 with lamp 	

Roller blinds controls

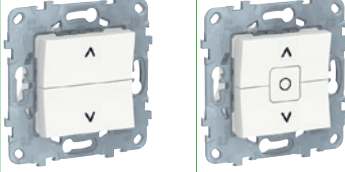
	Push-button - 6 A	Switch - 6 A
2 modules		
		
<input type="checkbox"/> white	NU520718	NU520818
<input type="checkbox"/> aluminium	NU520730	NU520830
<input type="checkbox"/> beige	NU520744	NU520844
<input type="checkbox"/> anthracite	NU520754	NU520854

Room indicators

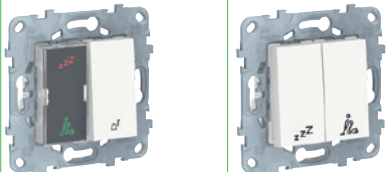
	Lamp and bell push-button	Control unit
2 modules		
		
<input type="checkbox"/> white	NU577718	NU521718
<input type="checkbox"/> aluminium	NU577730	NU521730
<input type="checkbox"/> beige	NU577744	NU521744
<input type="checkbox"/> anthracite	NU577754	NU521754

Card push-buttons

	10 A NO/NC
2 modules	
	
<input type="checkbox"/> white	NU528318
<input type="checkbox"/> aluminium	NU528330
<input type="checkbox"/> beige	NU528344
<input type="checkbox"/> anthracite	NU528354

Cord push-buttons

	10 A NO/NC
2 modules	
	
<input type="checkbox"/> white	NU522618
<input type="checkbox"/> beige	NU522644

Inserts with fixing frame

Comfort controls





Motion sensors

With push-button

2 modules

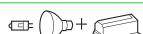
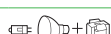

<input type="checkbox"/> white	NU552518
<input type="checkbox"/> aluminium	NU552530
<input type="checkbox"/> beige	NU552544
<input type="checkbox"/> anthracite	NU552554

Maximum loads	
LED lamp 230 V 	200 W
incandescent lamp 230 V 	2200 W
halogen lamp 230 V 	2000 W
motor (single-phase) 230 V 	1000 VA
LV electronic halogen transformer lamps 12 V 	1050 VA
wound transformer 	500 VA

- Characteristics**
- Rated current: 10 A
 - Screw terminal connection
 - Wire configuration without neutral
 - Movement detection area: 8 m frontal, 8 m lateral
 - Remote control by unlimited number of auxiliary push-button
 - Automatic load detection
 - Time delay range: 1...30 min
 - Master/slave option; connecting two sensors together for covering larger area



Dimmers

Universal

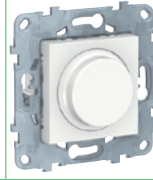
2 modules



<input type="checkbox"/> white	NU551418
<input type="checkbox"/> aluminium	NU551430
<input type="checkbox"/> beige	NU551444
<input type="checkbox"/> anthracite	NU551454

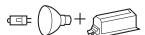
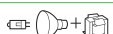

Maximum loads	
LED lamp 230 V 	RC: 5...100 VA RL: 5...20 VA
incandescent lamp 230 V 	5...200 W
halogen lamp 230 V 	5...150 W
LV electronic halogen lamps 12 V 	5...150 VA
wound transformer 	5...150 VA

- Characteristics**
- Remote control by unlimited number of auxiliary push-button
 - Automatic load detection
 - Wire configuration without neutral
 - Screw terminal connection
 - Memory function
 - Automatic overload protection, overheating protection, short-circuit protection

Thermostats

Room - 8 A Floor - 10 A

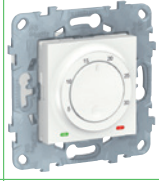
2 modules

<input type="checkbox"/> white	NU550118	NU550318
<input type="checkbox"/> aluminium	NU550130	NU550330
<input type="checkbox"/> beige	NU550144	NU550344
<input type="checkbox"/> anthracite	NU550154	NU550354

- Characteristics**
- For heating and air-conditioning
 - Settings range: + 5 to + 30 °C
 - Blue and red LED's for conditioning or heating indication
 - For floor heating
 - Settings range: + 5 to + 45 °C
 - Green LED for voltage supply indication
 - Red LED for heating indication
 - Delivered with a 4 m temperature sensor

Timers

Countdown timer relay - 10 A

2 modules



<input type="checkbox"/> white	NU553518
<input type="checkbox"/> aluminium	NU553530
<input type="checkbox"/> beige	NU553544
<input type="checkbox"/> anthracite	NU553554

- Characteristics**
- Time delay range: 5 min to 8 h
 - Integrated status LED
 - 3-wires (neutral required)

Inserts with fixing frame

Sockets

German sockets-outlets

	With shutters			Without shutters	
	screwless terminal	screw terminal	with lid	screwless terminal	screw terminal
2 modules					
<input type="checkbox"/> white	NU505718	NU503718	NU503718TA	NU505618	NU503618
<input type="checkbox"/> aluminium	NU505730	NU503730	NU503730TA	NU505630	NU503630
<input type="checkbox"/> beige	NU505744	NU503744	NU503744TA	NU505644	NU503644
<input type="checkbox"/> anthracite	NU505754	NU503754	NU503754TA	NU505654	NU503654
<input type="checkbox"/> red	-	NU503703		-	-

- Characteristics**
- 2P+E - 16 A - 250 V

	With cover frame	
	simple	double
<input type="checkbox"/> white	NU203718	NU206718
<input type="checkbox"/> aluminium	-	NU206730
<input type="checkbox"/> beige	-	NU206744
<input type="checkbox"/> anthracite	-	NU206754

- Characteristics**
- Screw terminal
 - Installation in 1 gang box

European sockets-outlets

	16 A	2 x 10 A
2 modules		
<input type="checkbox"/> white	NU503318	NU503118
<input type="checkbox"/> aluminium	NU503330	NU503130
<input type="checkbox"/> beige	NU503344	NU503144
<input type="checkbox"/> anthracite	NU503354	NU503154

- Characteristics**
- 2P - 250 V
 - Screw terminal

Double	with cover frame
<input type="checkbox"/> white	NU206318
<input type="checkbox"/> beige	NU206344

- Characteristics**
- 2P - 16 A - 250 V
 - Screw terminal
 - Installation in 1 gang box

Shaver sockets

	20 VA
<input type="checkbox"/> white	MGU5.064.18
<input type="checkbox"/> aluminium	MGU5.064.30

- Characteristics**
- 3 modules
 - Input: 240 V
 - Output: 115/240 V

Accessories

Red LED lamp
NU9830

- Characteristics**
- Plug&Play

Inserts with fixing frame Sockets

Data sockets

RJ45	Cat. 5e UTP zamak fixing frame	Cat. 6 UTP zamak fixing frame
2 modules		
white	NU541118	NU541518
aluminium	NU541130	NU541530
beige	NU541144	NU541544
anthracite	NU541154	NU541554
2 x1 module		
white	NU542018	NU542418
aluminium	NU542030	NU542430
beige	NU542044	NU542444
anthracite	NU542054	NU542454

Characteristics

- Connector Actassi S-One
- With shutter and label space

Multimedia sockets

	HDMI	VGA + mini Jack	RCA
2 x 1 module			
white	NU543018	NU593218	NU543118
aluminium	NU543030	NU593230	NU543130
beige	NU543044	NU593244	NU543144
anthracite	NU543054	NU593254	NU543154
Characteristics			
	<ul style="list-style-type: none"> • Connector prewired 	<ul style="list-style-type: none"> • Connector prewired • HD15 female • 3,5 mm connector 	<ul style="list-style-type: none"> • Video & audio • 3 connectors

RJ45 Centre plates

	For Keystone/Systimax RJ45 connector straight
2 modules	
white	NU546118
aluminium	NU546130
beige	NU546144
anthracite	NU546154
Characteristics	
<ul style="list-style-type: none"> • With shutter and label space 	

Telephone sockets

RJ11	
2 modules	
white	NU549218
aluminium	NU549230
beige	NU549244
anthracite	NU549254



USB data sockets and chargers

	Charger type A	Charger type A+C
2 modules		
white	NU541818	NU501818
aluminium	NU541830	NU501830
beige	NU541844	NU501844
anthracite	NU541854	NU501854
Data socket		
2 modules		
white	NU542718	
aluminium	NU542730	
beige	NU542744	
anthracite	NU542754	
Characteristics		
	<ul style="list-style-type: none"> • USB 2.0 • Output power: <ul style="list-style-type: none"> - NU5418●●: 5 V DC - 1.1A + 2A 	<ul style="list-style-type: none"> • Output power: <ul style="list-style-type: none"> - NU5018●●: 5 V DC - 1.2A + 2.4A



Inserts with fixing frame

Sockets

Radio and television sockets



	TV male			R-TV/SAT		
	individual	intermediate	terminal	individual	intermediate	terminal
2 modules						
						
□ white	NU546218	NU546318	NU546418	NU545418	NU545618	NU545518
■ aluminium	NU546230	NU546330	NU546430	NU545430	NU545630	NU545530
■ beige	NU546244	NU546344	NU546444	NU545444	NU545644	NU545544
■ anthracite	NU546254	NU546354	NU546454	NU545454	NU545654	NU545554

Radio and television centre plates Data and television sockets

	TV/FM	R-TV/SAT
	2 modules	
		
□ white	NU944018	NU944118
■ aluminium	NU944030	NU944130
■ beige	NU944044	-
■ anthracite	NU944054	NU944154

	Simple	RJ45 + TV
	2 x 1 module	
		
□ white	NU547018	
■ aluminium	NU547030	
■ anthracite	NU547054	

Loudspeakers connectors

	Simple	Double
	2 modules 2 x 1 module	
		
□ white	NU548618	NU548918
■ aluminium	NU548630	NU548930
■ beige	NU548644	NU548944
■ anthracite	NU548654	NU548954

Characteristics
● RJ45 cat. 6 UTP
● TV male individual

Inserts with fixing frame

Complementary offer

Blind covers

2 modules

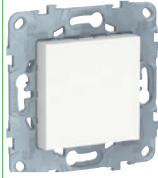

<input type="checkbox"/> white	NU586618
<input type="checkbox"/> aluminium	NU586630
<input type="checkbox"/> beige	NU586644
<input type="checkbox"/> anthracite	NU586654

Cable Outlets

2 modules

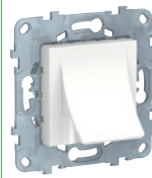

<input type="checkbox"/> white	NU586218
<input type="checkbox"/> aluminium	NU586230
<input type="checkbox"/> beige	NU586244
<input type="checkbox"/> anthracite	NU586254

Characteristics

- cable outer diameter: 12 mm

Unica
Wiser



Inserts with fixing frame

Wiser controls





Wiser push button relay switches

10 A	
2 modules	
	
<input type="checkbox"/> white	NU553718
<input type="checkbox"/> aluminium	NU553730
<input type="checkbox"/> beige	NU553744
<input type="checkbox"/> anthracite	NU553754
Characteristics	
<ul style="list-style-type: none"> • Relay switch for various purposes such as weekly scheduling using Wiser App, presence simulation, count-down timer • LED indicates when switch is on • Remote control from smartphone or tablet using Wiser App 	

Wiser blind control switches

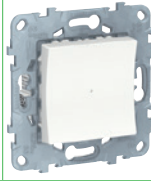
2 modules	
	
<input type="checkbox"/> white	NU550818
<input type="checkbox"/> aluminium	NU550830
<input type="checkbox"/> beige	NU550844
<input type="checkbox"/> anthracite	NU550854
Characteristics	
<ul style="list-style-type: none"> • Control of blinds locally from the switch or remotely from smartphone or tablet using Wiser App • Weekly scheduling • Astro function • Presence simulation • Can be used for controlling up to 10 multiple relays, each controlling one blind motor 	

Wiser dimmers

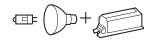
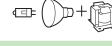
2 modules		Push-button	Rotary
			
<input type="checkbox"/> white		NU551518	NU551618
<input type="checkbox"/> aluminium		NU551530	NU551630
<input type="checkbox"/> beige		NU551544	NU551644
<input type="checkbox"/> anthracite		NU551554	NU551654
Maximum loads			
LED lamp 230 V		RC: 7...100 VA RL : 7...20 VA	RC: 7...100 VA RL : 7...20 VA
incandescent lamp 230 V		14...200 W	14...200 W
halogen lamp 230 V		14...150 W	14...150 W
LV halogen lamps 12 V	electronic transformer 	14...150 W	14...150 W
	wound transformer 	14...150 W	14...150 W
Characteristics			
<ul style="list-style-type: none"> • Remote control from auxiliary push-buttons • Automatic load detection • Wire configuration without neutral • Memory function • Automatic overload protection, overheating protection, short-circuit protection • Additional functions like wake-up, fall asleep, scheduling... can be activated using the Wiser App 			

Inserts with fixing frame

Wiser comfort controls

Wiser thermostats

Room and Floor thermostat - 16 A



<input type="checkbox"/> white	NU550518
<input type="checkbox"/> aluminium	NU550530
<input type="checkbox"/> beige	NU550544
<input type="checkbox"/> anthracite	NU550554

- Characteristics**
- Combined room and floor thermostat
 - Can be controlled manually or with smartphone or tablet
 - AWAY activation option from touch push-button
 - Weekly scheduling
 - Frost protection mode
 - Opti start function
 - Built-in open window recognition

Wiser motion sensors

2 modules	With relay switch	With dimmer
-----------	-------------------	-------------

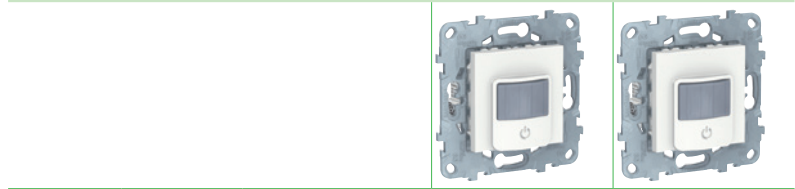

<input type="checkbox"/> white	NU552618	NU552718
<input type="checkbox"/> aluminium	NU552630	NU552730
<input type="checkbox"/> beige	NU552644	NU552744
<input type="checkbox"/> anthracite	NU552654	NU552754

Maximum loads			
LED lamp 230 V		200 W	RC: 7...100 VA RL: 7...20 VA
compact fluorescent lamp		200 W	-
incandescent lamp 230 V		2200 W	14...200 W
halogen lamp 230 V		2000 W	14...150 W
LV halogen lamps 12 V	electronic transformer	1050 VA	14...150 W
	wound transformer	500 VA	14...150 W

- Characteristics**
- Wire configuration with neutral
 - Movement detection area 8 m frontal, 8 m lateral
 - Movement detection angle: 160 °
 - Configuration with time delay range, triggering light level... is done using the Wiser App
 - Built-in push button switch for dim (only with dimmer version) and on/off switching
- See Wiser dimmers for others characteristics

Unica

Inserts

Wiser comfort controls





Wiser relay switches

10 A	
2 modules	
	
<input type="checkbox"/> white	NU353718
<input type="checkbox"/> aluminium	NU353730
<input type="checkbox"/> anthracite	NU353754
Characteristics	
<ul style="list-style-type: none"> Relay switch for various purposes such as weekly scheduling using Wiser App, presence simulation, count-down timer LED indicates when switch is on Remote control from smartphone or tablet using Wiser App 	





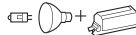
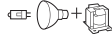

Wiser blind control switches

4 A	
2 modules	
	
<input type="checkbox"/> white	NU350818
<input type="checkbox"/> aluminium	NU350830
<input type="checkbox"/> anthracite	NU350854
Characteristics	
<ul style="list-style-type: none"> Control of blinds locally from the switch or remotely from smartphone or tablet using Wiser App Weekly scheduling Can be used for controlling up to 10 multiple relays, each controlling one blind motor 	

Wiser dimmers

		Push-button	Rotary
2 modules			
			
<input type="checkbox"/> white		NU351518	NU351618
<input type="checkbox"/> aluminium		NU351530	NU351630
<input type="checkbox"/> anthracite		NU351554	NU351654
Maximum loads			
LED lamp 230 V		RC: 7...100 VA RL: 7...20 VA	RC: 7...100 VA RL: 7...20 VA
incandescent lamp 230 V		14...200 W	14...200 W
halogen lamp 230 V		14...150 W	14...150 W
LV halogen lamps 12 V	electronic transformer 	14...150 W	14...150 W
	wound transformer 	14...150 W	14...150 W
Characteristics			
<ul style="list-style-type: none"> Remote control from auxiliary push-buttons Automatic load detection Wire configuration without neutral Memory function Automatic overload protection, overheating protection, short-circuit protection Additional functions like wake-up, fall asleep, scheduling... can be activated using the Wiser App 			

Wiser motion sensors

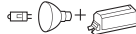
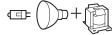
		with relay switch	with dimmer
2 modules			
			
<input type="checkbox"/> white		NU352618	NU352718
<input type="checkbox"/> aluminium		NU352630	NU352730
<input type="checkbox"/> anthracite		NU352654	NU352754
Maximum loads			
LED lamp 230 V		200 W	RC: 7...100 VA RL: 7...20 VA
compact fluorescent lamp		200 W	-
incandescent lamp 230 V		2200 W	14...200 W
halogen lamp 230 V		2000 W	14...150 W
LV halogen lamps 12 V	electronic transformer 	1050 VA	14...150 W
	wound transformer 	500 VA	14...150 W
Characteristics			
<ul style="list-style-type: none"> Wire configuration with neutral Movement detection area 8 m frontal, 8 m lateral Movement detection angle: 160 ° Configuration with time delay range, triggering light level... is done using the Wiser App Built-in push button switch for dim (only with dimmer version) and on/off switching 			
			<ul style="list-style-type: none"> See Wiser dimmers for others characteristics

Unica antibacterial Inserts

Wiser comfort controls







Wiser relay switch

10 A	
2 modules	
	
<input type="checkbox"/> white	NU353720
Characteristics	
<ul style="list-style-type: none"> Relay switch for various purposes such as weekly scheduling using Wiser App, presence simulation, count-down timer LED indicates when switch is on Remote control from smartphone or tablet using Wiser App 	







Wiser blind control switch

4 A	
2 modules	
	
<input type="checkbox"/> white	NU350820
Characteristics	
<ul style="list-style-type: none"> Control of blinds locally from the switch or remotely from smartphone or tablet using Wiser App Weekly scheduling Presence simulation Can be used for controlling up to 10 multiple relays, each controlling one blind motor 	

Wiser dimmers

	Push-button	Rotary
2 modules		
<input type="checkbox"/> white	 NU351520	 NU351620
Maximum loads		
LED lamp 230 V	 RC: 7...100 VA RL : 7...20 VA	RC: 7...100 VA RL : 7...20 VA
incandescent lamp 230 V	 14...200 W	14...200 W
halogen lamp 230 V	 14...150 W	14...150 W
LV halogen lamps 12 V	electronic transformer  14...150 W	14...150 W
	wound transformer  14...150 W	14...150 W
Characteristics		
<ul style="list-style-type: none"> Remote control from auxiliary push-buttons Automatic load detection Wire configuration without neutral Memory function Automatic overload protection, overheating protection, short-circuit protection Additional functions like wake-up, fall asleep, scheduling... can be activated using the Wiser App 		

Wiser motion sensors

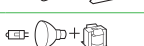
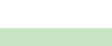
	with relay switch	with dimmer
2 modules		
<input type="checkbox"/> white	 NU352620	 NU352720
Maximum loads		
LED lamp 230 V	 200 W	RC: 7...100 VA RL : 7...20 VA
compact fluorescent lamp	 200 W	-
incandescent lamp 230 V	 2200 W	14...200 W
halogen lamp 230 V	 2000 W	14...150 W
LV halogen lamps 12 V	electronic transformer  1050 VA	14...150 W
	wound transformer  500 VA	14...150 W
Characteristics		
<ul style="list-style-type: none"> Wire configuration with neutral Movement detection area 8 m frontal, 8 m lateral Movement detection angle: 160 ° Configuration with time delay range, triggering light level... is done using the Wiser App Built-in push button switch for dim (only with dimmer version) and on/off switching 		
		<ul style="list-style-type: none"> See Wiser dimmers for others characteristics

Unica
Fixing frames
Boxes
& Cover frames







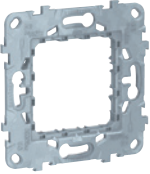

Content

76 Fixing frames

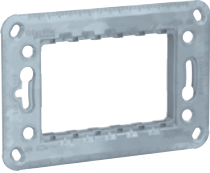

77 Boxes

78 Cover frames

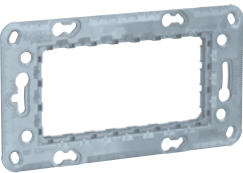





Fixing frames

1 gang or 2 modules		
Zamak	Plastic	Plastic with paint protector
		
NU7002	NU7002P	NU7002PC
2 gangs or 4 modules		
Plastic with paint protector	Zamak with paint protector	Zamak with paint protector
		
NU7004PC	NU7006C	NU7008C
3 modules		4 modules
Zamak	Plastic	Zamak
		
NU7103	NU7103P	NU7104
Characteristics		
<ul style="list-style-type: none"> Delivered with paint protection 		



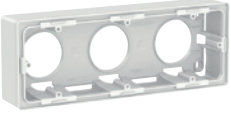



Accessories

Claws	Paint protector	Adaptor
		
NU7892	NU7802	U0.582
Characteristics		
<ul style="list-style-type: none"> For zamak fixing frames With green plastic protection 	<ul style="list-style-type: none"> For 2 modules 	<ul style="list-style-type: none"> For MGU7.●●● fixing frames

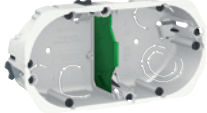
Surface boxes

	1 gang	2 gangs	3 gangs
For Unica Studio cover frames			
			
□ white	NU800218	NU800418	NU800618
■ beige	NU800244	NU800444	NU800644
For Unica Pro cover frames			
			
□ white	NU840218	NU840418	NU840618

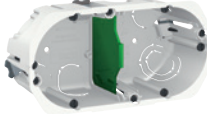
Multifix flush mounting boxes

1 gang	2 gangs	3 gangs	4 gangs
40 mm depth			
			
IMT35914 ⁽¹⁾ IMT35914P ⁽²⁾	IMT35924	IMT35934	IMT35944
50 mm depth			
			
IMT35915	IMT35925	IMT35935	IMT35945

- (1) pack of 50 units.
(2) pack of 300 units.



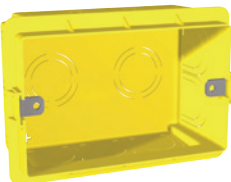
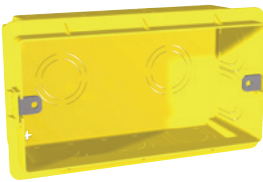









Flush mounting boxes

1 module	3 modules	4 modules
		
MGU8.601	MGU8.603	MGU8.604

Accessories

Divider	
	
IMT35994	IMT35995
Characteristics	
● for 40 mm depth boxes	● for 50 mm depth boxes





















Studio

	white	aluminium	beige	anthracite
				
1 gang (2 mod.) 	NU200218	NU200230	NU200244	NU200254
2 gangs (2 x 2 mod.) 	NU200418	NU200430	NU200444	NU200454
3 gangs (4 x 2 mod.) 	NU200618	NU200630	NU200644	NU200654
4 gangs (4 x 2 mod.) 	NU200818	NU200830	NU200844	NU200854
5 gangs (4 x 2 mod.) 	NU201018	NU201030	NU201044	NU201054
1 module 	NU210118	NU210130	-	NU210154
2 modules 	NU210218	NU210230	-	NU210254
3 modules 	NU210318	NU210330	-	NU210354
4 modules 	NU210418	NU210430	-	NU210454

Studio Color

Front colour	light green		red	plum		chocolate		white
Back colour	white	beige	white	white	beige	white	black	white
								
1 gang (2 mod.) 	NU280211	NU280212	NU280213	NU280214	NU280215	NU280216	NU280217	NU280218
2 gangs (2 x 2 mod.) 	NU280411	NU280412	NU280413	NU280414	NU280415	NU280416	NU280417	NU280418
3 gangs (4 x 2 mod.) 	NU280611	NU280612	NU280613	NU280614	NU280615	NU280616	NU280617	NU280618
4 gangs (4 x 2 mod.) 	NU280811	NU280812	NU280813	NU280814	NU280815	NU280816	NU280817	NU280818
Front colour	dark grey		light grey	taupe		beige		
Back colour	white	black	white	white	beige	black	beige	
								
1 gang (2 mod.) 	NU280221	NU280222	NU280224	NU280226	NU280227	NU280228	NU280244	
2 gangs (2 x 2 mod.) 	NU280421	NU280422	NU280424	NU280426	NU280427	NU280428	NU280444	
3 gangs (4 x 2 mod.) 	NU280621	NU280622	NU280624	NU280626	NU280627	NU280628	NU280644	
4 gangs (4 x 2 mod.) 	NU280821	NU280822	NU280824	NU280826	NU280827	NU280828	NU280844	











Studio Metal

Front colour	bronze			dark aluminium	white aluminium		copper	
Back colour	white	beige	black	black	white	black	white	black
								
1 gang (2 mod.) 	NU280250	NU280251	NU280252	NU280253	NU280255	NU280256	NU280257	NU280258
2 gangs (2 x 2 mod.) 	NU280450	NU280451	NU280452	NU280453	NU280455	NU280456	NU280457	NU280458
3 gangs (4 x 2 mod.) 	NU280650	NU280651	NU280652	NU280653	NU280655	NU280656	NU280657	NU280658
4 gangs (4 x 2 mod.) 	NU280850	NU280851	NU280852	NU280853	NU280855	NU280856	NU280857	NU280858
4 modules for double gang box 	NU281450	-	NU281452	NU281453	NU281455	NU281456	-	-
Front colour	gold							
Back colour	white	beige	black					
								
1 gang (2 mod.) 	NU280259	NU280260	NU280262					
2 gangs (2 x 2 mod.) 	NU280459	NU280460	NU280462					
3 gangs (4 x 2 mod.) 	NU280659	NU280660	NU280662					
4 gangs (4 x 2 mod.) 	NU280859	NU280860	NU280862					



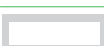

Pure

	aluminium	rubber	nordic Wood	wood oak	glass frost- ed white	glass frost- ed black	slate	translucide white
								
1 gang (2 mod.) 	NU600280	NU600282	NU600283	NU600284	NU600285	NU600286	NU600287	NU600289
2 gangs (2 x 2 mod.) 	NU600480	NU600482	NU600483	NU600484	NU600485	NU600486	NU600487	NU600489
	NU6004V80	NU6004V82	NU6004V83	NU6004V84	NU6004V85	NU6004V86	NU6004V87	NU6004V89
3 gangs (4 x 2 mod.) 	NU600680	NU600682	NU600683	NU600684	NU600685	NU600686	NU600687	NU600689
4 gangs (4 x 2 mod.) 	NU600880	NU600882	NU600883	NU600884	NU600885	NU600886	NU600887	NU600889



Pro

	white	aluminium	anthracite
			
1 gang (2 mod.) 	NU400218	NU400230	NU400254
2 gangs (2 x 2 mod.) 	NU400418	NU400430	NU400454
3 gangs (4 x 2 mod.) 	NU400618	NU400630	NU400654
4 gangs (4 x 2 mod.) 	NU400818	NU400830	NU400854
4 modules for double gang box 	NU411418	NU411430	NU411454
6 modules for triple gang box 	NU411618	NU411630	NU411654
8 modules for triple gang box 	NU411818	NU411830	NU411854
10 modules for quadruple gang box 	NU411018	NU411030	NU411054

Thin panels

	white	aluminium	anthracite
			
1 module 	NU200118	NU200130	NU200154



IP 44 cover frame

	white
	
1 gang (2 mod.) 	NU044218





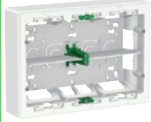
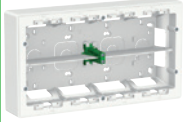
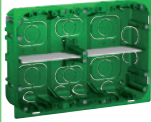
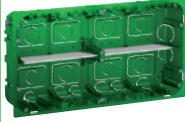



Unica System+

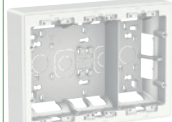
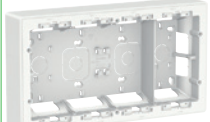

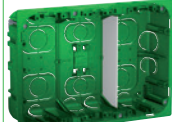
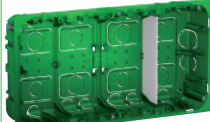



Horizontal centralization boxes

	3 gang 8 modules	4 gang 10 modules
Surface boxes		
		
□ white	NU821820	NU821020
■ aluminium	NU821830	NU821030
■ anthracite	NU821854	NU821054
Flush mounting boxes		
		
	NU8718	NU8710
Cover frame with fixing frame		
		
□ white	NU021820	NU021020
■ aluminium	NU021830	NU021030
■ anthracite	NU021854	NU021054



Vertical centralization boxes

	2 columns x 4 modules	3 columns x 4 modules	4 columns x 4 modules
Surface boxes			
			
□ white	NU822418	NU823418	NU824418
Flush mounting boxes			
			
	NU8724	NU8734	NU8744
Cover frame with fixing frame			
			
□ white	NU022418	NU023418	NU024418
Kits (insert + cover frame)			
			
□ white	NU112118 • 2 German sockets-outlets + 2 Centre plates without RJ45 connectors	NU113118 • 2 German sockets-outlets + 2 German red sockets-outlets + 2 Centre plates without RJ45 connectors	NU114118 • 4 German sockets-outlets + 2 German red sockets-outlets + 2 Centre plates without RJ45 connectors

Accessories

Link accessory for surface workstation	Fixing frame	Metal divider for flush mounting boxes		DIN rail adapter
				
U22.805	NU7204P	NU9802	NU9801	NU9800
Characteristics				
	• for vertical solutions			• for Acti9 devices installation (1 or 2 modules of 18 mm)

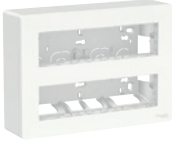
Horizontal surface mounting workstations

	2 rows x 8 modules	2 rows x 10 modules
		

<input type="checkbox"/> white	NU121820	NU121020
--------------------------------	-----------------	-----------------

Vertical surface mounting workstations

	2 columns x 4 modules	3 columns x 4 modules	4 columns x 4 modules
			

<input type="checkbox"/> white	NU122418	NU123418	NU124418
<input type="checkbox"/> aluminium	NU122430	NU123430	NU124430
<input type="checkbox"/> anthracite	NU122454	NU123454	NU124454

Horizontal flush mounting workstations

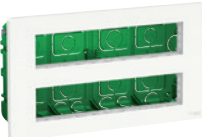
	2 rows x 8 modules	2 rows x 10 modules
		

<input type="checkbox"/> white	NU171820	NU171020
--------------------------------	-----------------	-----------------

Vertical flush mounting workstations

	2 columns x 4 modules	3 columns x 4 modules	4 columns x 4 modules
			

<input type="checkbox"/> white	NU172418	NU173418	NU174418
<input type="checkbox"/> aluminium	NU172430	NU173430	NU174430
<input type="checkbox"/> anthracite	NU172454	NU173454	NU174454



Unica
KNX

The following Unica control devices have to be connected to KNX bus line.
The KNX bus line is laid in parallel to the 230 V power supply.
When Unica sensor is activated, an actuator (e.g. the roller shutter control) will carry out all the switching commands required.

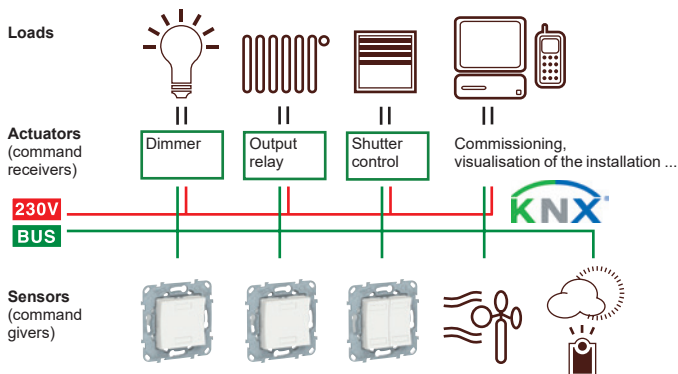
Introduction



Controls

Push-buttons	2 buttons and 2 blue status LEDs, with screwless bus connecting terminals	4 buttons and 4 blue status LEDs, with screwless bus connecting terminals
2 modules		
		
<input type="checkbox"/> white	NU553018	NU553118
<input type="checkbox"/> white antibacterial	NU553020	NU553120
<input type="checkbox"/> aluminium	NU553030	NU553130
<input type="checkbox"/> anthracite	NU553054	NU553154
Characteristics		
	<ul style="list-style-type: none"> The status LED is located under the symbol window which can be taken off. With integrated bus coupler. The bus is connected using a bus connecting terminal. Contents: <ul style="list-style-type: none"> With set of 10 symbols: <ul style="list-style-type: none"> 2 x symbol with light opening, 1 x symbol "1", 1 x symbol "0", 2 x symbol for dimming, 2 x symbol for shutter, 2 x symbol (neutral). With bus connecting terminal. 	<ul style="list-style-type: none"> The status LED is located under the symbol window which can be taken off. With integrated bus coupler. The bus is connected using a bus connecting terminal. Contents: <ul style="list-style-type: none"> With set of 20 symbols: <ul style="list-style-type: none"> 4 x symbol with light opening, 2 x symbol "1", 2 x symbol "0", 4 x symbol for dimming, 4 x symbol for shutter, 4 x symbol (neutral). With bus connecting terminal.
KNX software functions: Switching, toggling, dimming (single/dual-surface), blind (single/dual-surface), pulse edges trigger 1-, 2-, 4- or 8-bit telegrams (distinction between short and long operation), pulse edges with 2-byte telegrams (distinction between short and long operation), 8-bit linear regulator, scene retrieval, scene saving, disable functions.		

Unica Antibacterial



10 AX - 250 V AC switches

Two-way	
2 modules	
<input type="checkbox"/> white	NU320320
1 module	
<input type="checkbox"/> white	NU310320
Characteristics	
<ul style="list-style-type: none"> • Connection: screwless terminals • Cables: 1 to 2,5 mm² rigid/flexible • Lightable with NU9825A, NU9823AM and NU9825AZ LED lamps and rockers with visor 	

10 A - 250 V AC push-buttons

	NO without symbol	NO/NC with label holder	NO with location lamp without symbol
2 modules			
<input type="checkbox"/> white	NU320620	NU324620	NU320620N
1 module			
<input type="checkbox"/> white	NU310620		
Characteristics			
<ul style="list-style-type: none"> • Connection: screwless terminals • Cables: 1.5 to 2.5 mm² rigid/flexible • Lightable with NU9825A, NU9823AM and NU9825AZ LED lamps and rockers with visor 			

Accessories for switches and push-buttons

Rockers	without symbol	with visor
2 modules		
<input type="checkbox"/> white	NU920020	NU920020N
1 module		
<input type="checkbox"/> white	NU910020	NU910020N

LED lamps	12-24 V DC	250 V AC	
	white	red	white
	NU9823AM	NU9825A	NU9825AZ
Characteristics			
Consumption	0.15 mA	1,5 mA	0,05 mA

Spring to transform a switch to push-button



S520299

Characteristics

- 10 units delivered with a positioning aid tool

Unica antibacterial Inserts Specialized controls

Fan control

	Two-way - 10 A
2 modules	
	
<input type="checkbox"/> white	NU320320VMC



Roller blinds control

	One-way - 6 A
2 modules	
	
<input type="checkbox"/> white	NU320820

Cord push-button

	NO/NC - 10 A
2 modules	
	
<input type="checkbox"/> white	NU322620

Dimmer

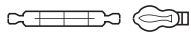
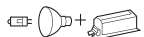
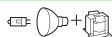
	Universal	
2 modules		
		
<input type="checkbox"/> white	NU351420	
Maximum loads		
LED lamp 230 V		RC: 5...100 VA RL : 5...20 VA
incandescent lamp 230 V		5...200 W
halogen lamp 230 V		5...150 W
LV halogen lamps 12 V	electronic transformer 	5...150 VA
	wound transformer 	5...150 VA
Characteristics		
<ul style="list-style-type: none"> • Remote control by unlimited number of auxiliary push-button • Automatic load detection • Wire configuration without neutral • Screw terminal connection • Memory function • Automatic overload protection, overheating protection, short-circuit protection 		

Unica antibacterial Inserts Sockets

French sockets-outlets

90°	Standard	Surface	Tamperproof
2 modules			
<input type="checkbox"/> white	NU305920	NU305220	-
<input checked="" type="checkbox"/> red	NU305903	NU305203	NU305103
<input checked="" type="checkbox"/> green	NU305906	NU305206	-

Characteristics

- 2P+E - 16 A - 250 V
- With shutters
- Screwless terminals (except NU305103)

German sockets-outlets

Centres plates	
2 modules	
<input type="checkbox"/> white	NU903720

45°	Standard			With lamp	Tamperproof		Tamperproof with lamp
	2 modules	4 modules	6 modules	4 modules	4 modules	6 modules	4 modules
<input type="checkbox"/> white	NU304920	-	-	-	-	-	-
<input checked="" type="checkbox"/> red	NU304903	NU306903	NU307903	NU306903S	NU306103	NU307103	NU306103S
<input checked="" type="checkbox"/> green	NU304906	NU306906	NU307906	-	-	-	-

Characteristics

- 2P+E - 16 A - 250 V
- With shutters
- Screwless terminals

French sockets-outlets for trunking

90°	Standard	Surface	Tamperproof
2 modules			
<input checked="" type="checkbox"/> red	NU305903T	NU305203T	NU305103T

Characteristics

- 2P+E - 16 A - 250 V
- With shutters
- Screwless terminals (except NU305103T)

45°	Standard			Tamperproof	
	2 modules	4 modules	6 modules	4 modules	6 modules
<input checked="" type="checkbox"/> red	NU304903T	NU306903T	NU307903T	NU306103T	NU307103T



Characteristics

- 2P+E - 16 A - 250 V
- With shutters
- Screwless terminals



RJ45 Centre plates

		For S-One RJ45 connector	
		straight	inclined
2 modules			
<input type="checkbox"/> white			
	NU941120	NU940720	
<input type="checkbox"/> white			
	NU942020		
1 module			
<input type="checkbox"/> white			
	NU941020	NU940620	
Characteristics			
<ul style="list-style-type: none"> • Straight : with shutter and label space • Inclined : with label space 			

Blind covers

2 modules	
<input type="checkbox"/> white	 NU986620
1 module	
<input type="checkbox"/> white	 NU986520

Radio and television sockets

		TV Male, individual	FM/TV/SAT Individual (1 cable)
2 modules			
<input type="checkbox"/> white			
	NU346220	NU345020	
1 module			
<input type="checkbox"/> white			
	NU346120	-	

Unica antibacterial

Inserts

Wiser controls







Wiser relay switches

10 A	
2 modules	
	
<input type="checkbox"/> white	NU353720
Characteristics	
<ul style="list-style-type: none"> Relay switch for various purposes such as weekly scheduling using Wiser App, presence simulation, count-down timer LED indicates when switch is on Remote control from smartphone or tablet using Wiser App 	





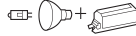



Wiser blind control switches

4 A	
2 modules	
	
<input type="checkbox"/> white	NU350820
Characteristics	
<ul style="list-style-type: none"> Control of blinds locally from the switch or remotely from smartphone or tablet using Wiser App Weekly scheduling Presence simulation Can be used for controlling up to 10 multiple relays, each controlling one blind motor 	



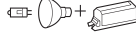

Wiser dimmers

		Push-button	Rotary
2 modules			
<input type="checkbox"/> white			
		NU351520	NU351620
Maximum loads			
LED lamp 230 V		RC: 7...100 VA RL: 7...20 VA	RC: 7...100 VA RL: 7...20 VA
incandescent lamp 230 V		14...200 W	14...200 W
halogen lamp 230 V		14...150 W	14...150 W
LV halogen lamps 12 V	electronic transformer 	14...150 W	14...150 W
	wound transformer 	14...150 W	14...150 W
Characteristics			
<ul style="list-style-type: none"> Remote control from auxiliary push-buttons Automatic load detection Wire configuration without neutral Memory function Automatic overload protection, overheating protection, short-circuit protection Additional functions like wake-up, fall asleep, scheduling... can be activated using the Wiser App 			

Wiser motion sensors

		with relay switch	with dimmer
2 modules			
<input type="checkbox"/> white			
		NU352620	NU352720
Maximum loads			
LED lamp 230 V		200 W	RC: 7...100 VA RL: 7...20 VA
compact fluorescent lamp		200 W	-
incandescent lamp 230 V		2200 W	14...200 W
halogen lamp 230 V		2000 W	14...150 W
LV halogen lamps 12 V	electronic transformer 	1050 VA	14...150 W
	wound transformer 	500 VA	14...150 W
Characteristics			
<ul style="list-style-type: none"> Wire configuration with neutral Movement detection area 8 m frontal, 8 m lateral Movement detection angle: 160 ° Configuration with time delay range, triggering light level... is done using the Wiser App Built-in push button switch for dim (only with dimmer version) and on/off switching 			
			<ul style="list-style-type: none"> see Wiser dimmers for others characteristics

Cover frames - Pro

		white
		
1 gang (2 mod.)		NU400220
2 gangs (2 x 2 mod.)		NU400420
4 modules		NU411420
6 modules		NU411620

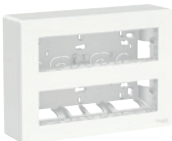
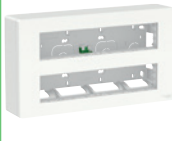

Surface mounting workstations

	2 rows x 8 modules	2 rows x 10 modules
		
<input type="checkbox"/> white	NU121820	NU121020

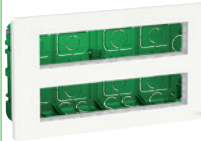
Flush mounting workstations

	2 rows x 8 modules	2 rows x 10 modules
		
<input type="checkbox"/> white	NU171820	NU171020

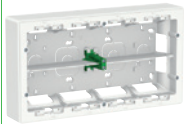
Horizontal centralization boxes

	2 rows x 8 modules	2 rows x 10 modules
Surface boxes		
		
<input type="checkbox"/> white	NU821820	NU821020
Cover frame with fixing frame		
		
<input type="checkbox"/> white	NU021820	NU021020

Unica Technical Informations

Content

Dimensions

98 [Unica](#)

101 [Unica System+](#)

Connections

104 [Control inserts](#)

106 [Comfort control inserts](#)

107 [Comfort Wiser inserts](#)

108 [Specialized control](#)

109 [Socket-outlets](#)

110 [RJ45 data sockets](#)

Dimensions

Fixing frames

Universal fixing frame

NU7002●●

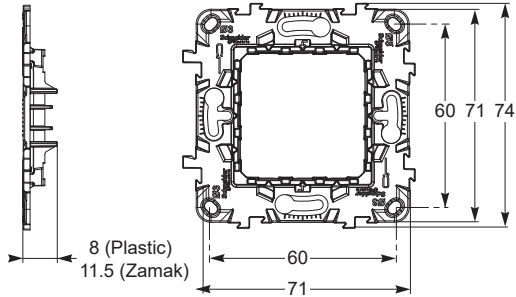

Zamak and plastic (2 modules)

NU7103●●

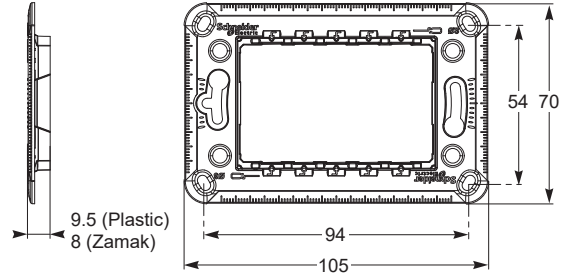

Zamak and plastic (3 modules)

Multigang fixing frames

NU7004PC

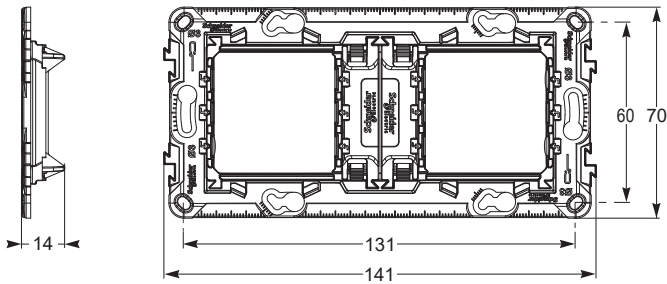

Plastic (2 gangs or 4 modules)

NU7006C

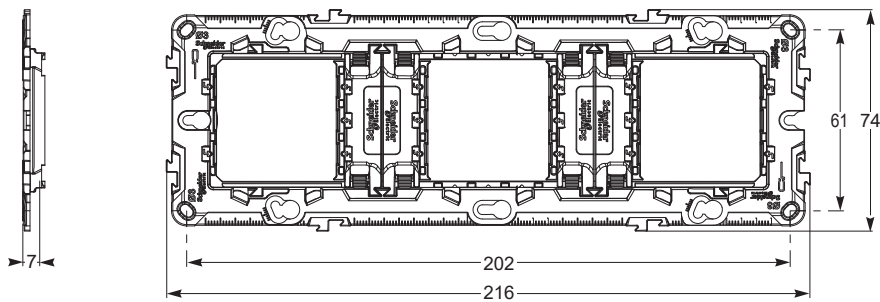

Zamak (3 gangs or 6/8 modules)

NU7008C

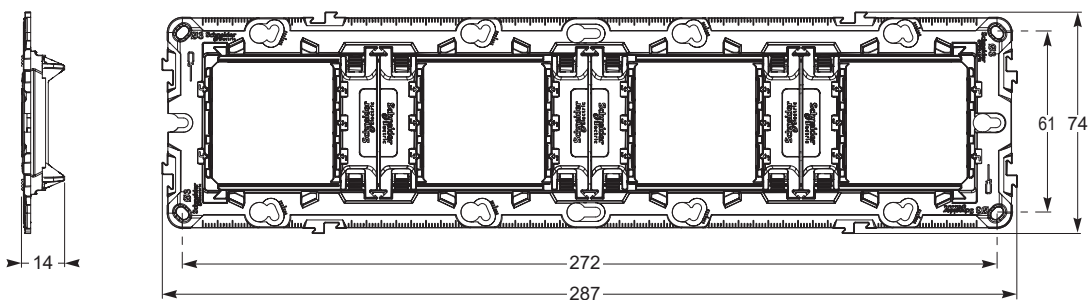

Zamak (4 gangs or 10 modules)

Unica Dimensions Boxes

Surface mounting boxes

NU800●18

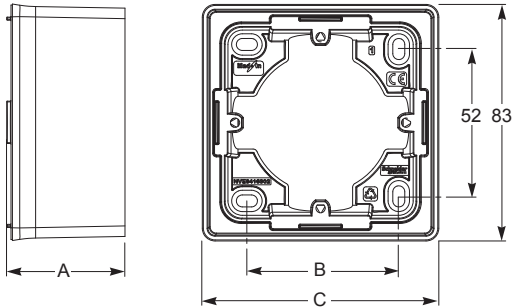

Unica Studio surface mounting boxes

NU800●44

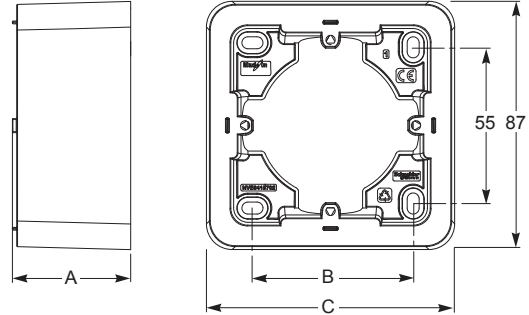

Unica Pro surface mounting boxes

Type	Depth	1 gang		2 gangs		3 gangs	
		A	B	C	B	C	B
Unica Studio	41.5	53	83	124	154	195	224
Unica Pro	41.5	56	87	128	158	199	229

Flush mounting boxes

IMT359●4: 40 mm depth
IMT359●5: 50 mm depth

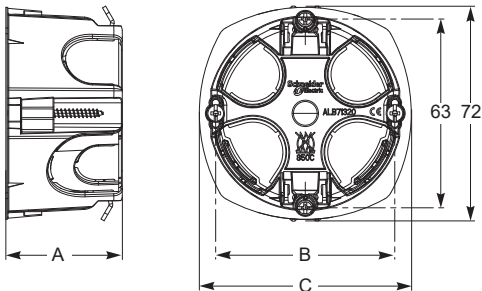

Multifix flush mounting boxes

Type	Depth		1 gang		2 gangs		3 gangs		4 gangs	
	IMT359●4	IMT359●5	B	C	B	C	B	C	B	C
Multifix	40	50	60	71	71	141.5	71 x 2	212,5	71 x 3	283

MGU8.601: 35 mm depth
MGU8.603, MGU8.604: 48 mm depth



Flush mounting boxes

Type	Depth		1 module	3 modules		4 modules	
	MGU8.601	MGU8.603/604	C	B	C	B	C
Box	35	48	26.5	83.5	106	108	131

Unica

Dimensions

Cover frames

Gangs

NU200●●●
NU280●●●

NU600●●●

NU400●●●

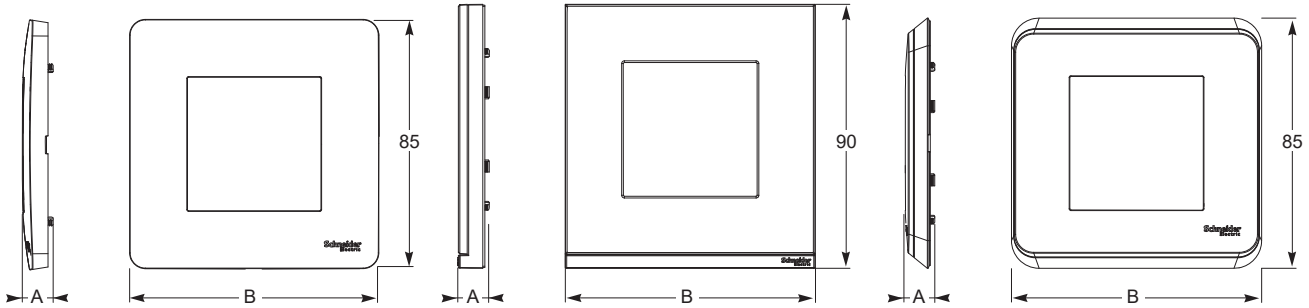

Unica Studio

Unica Pure

Unica Pro

Type	Depth	1 gang	2 gangs	3 gangs	4 gangs	5 gangs
	A	B	B	B	B	B
Unica Studio	10	85	156	227	298	369
Unica Pure	10	85	156	227	298	-
Unica Pro	10	85	156	227	298	-

Modules

NU210●●●

NU411●●●

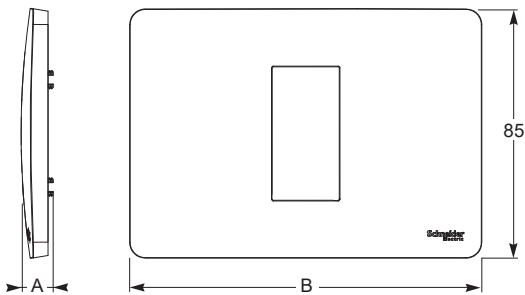

Unica Studio

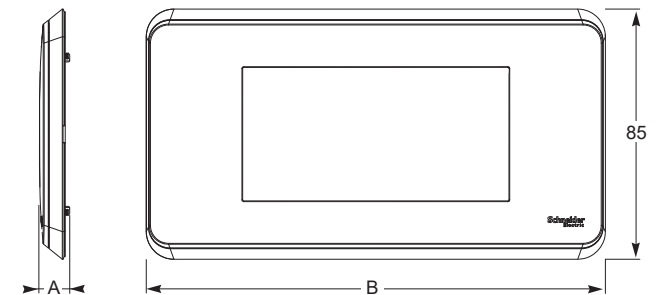

Unica Pro

Type	Depth	1, 2, 3 modules	4 modules
	A	B	B
Unica Studio	10	120	142

Type	Depth	4 modules	6, 8 modules	10 modules
	A	B	B	B
Unica Pro	10	156	227	298

Dimensions

Fixing frames & Cover frames

Fixing frames

NU7204P

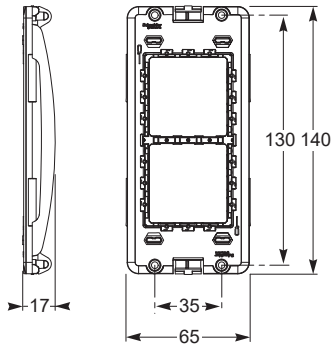

Cover frames

NU0218●●: 3 gangs - 6 or 8 modules

NU0210●●: 4 gangs - 10 modules

NU02●418: 2,3 and 4 columns - 4 modules

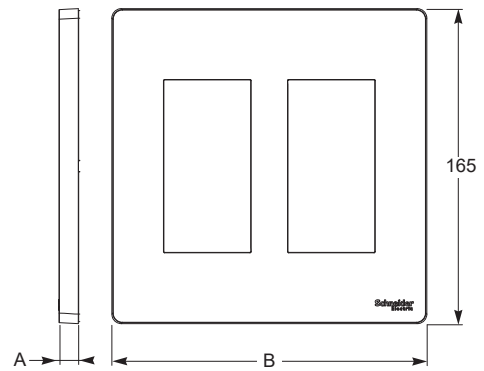
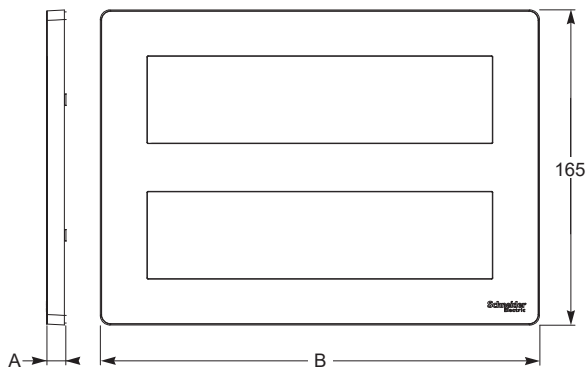

Horizontal cover frame

Vertical cover frame

Type	Depth	3 gangs 6 or 8 modules	4 gangs 10 modules	2 columns 4 modules	3 columns 4 modules	4 columns 4 modules
	A	B	B	B	B	B
Cover frames	10	230	300	165	230	300

Flush mounting boxes

NU8718●●: 3 gangs - 6 or 8 modules
NU8710●●: 4 gangs - 10 modules

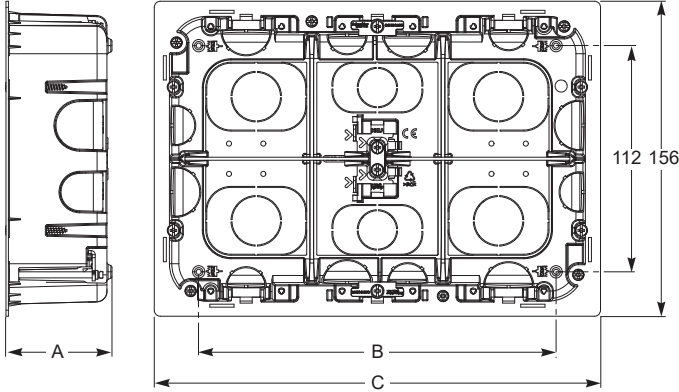

Horizontal flush centralization boxes

NU87●4: 2,3 and 4 columns - 8 modules

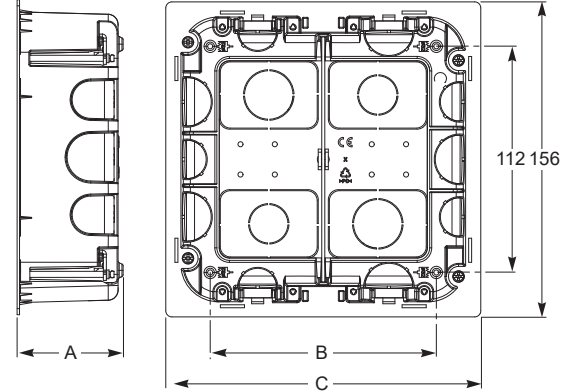

Vertical flush centralization boxes

Type	Depth	3 gangs 6 or 8 modules		4 gangs 10 modules		2 columns 4 modules		3 columns 4 modules		4 columns 4 modules	
		A	B	C	B	C	B	C	B	C	
Flush mounting boxes	52.5	177	221	248	292	71	141.5	177	221	248	292

Centralization boxes

NU8218●●: 3 gangs - 6 or 8 modules
NU8210●●: 4 gangs - 10 modules

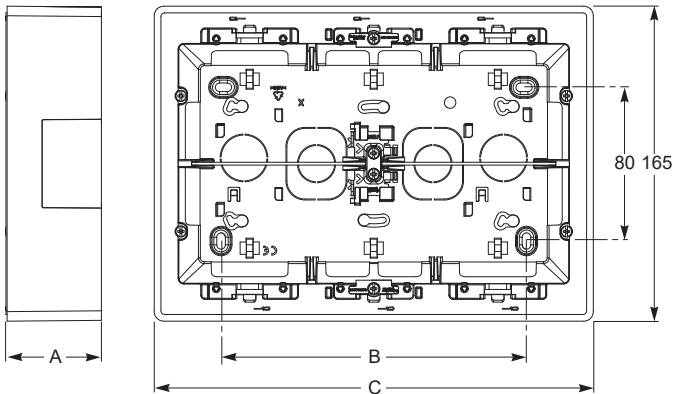

Horizontal centralization boxes

NU82●418: 2,3 and 4 columns - 8 modules

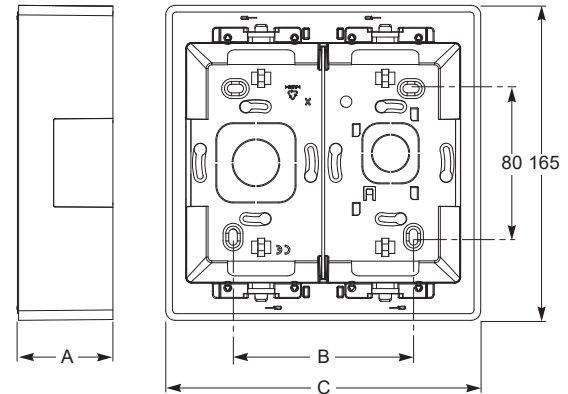

Vertical centralization boxes

Type	Depth	3 gangs 6 or 8 modules		4 gangs 10 modules		2 columns 4 modules		3 columns 4 modules		4 columns 4 modules	
		A	B	C	B	C	B	C	B	C	
Centralization boxes	50	160	230	233	300	94.5	165	160	230	233	300

Flush mounting workstations boxes

NU171•20: 2 rows - 8 or 10 modules

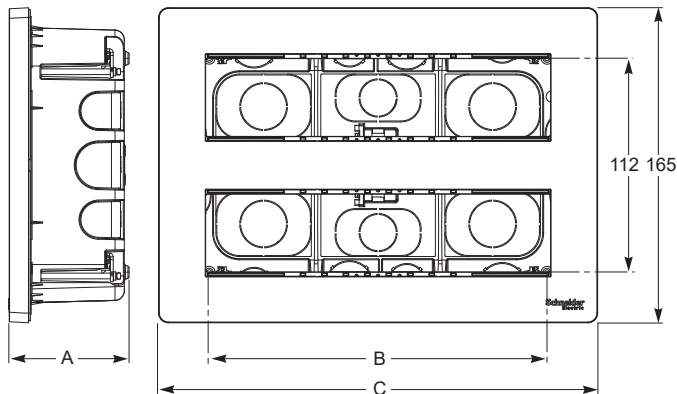

Horizontal flush mounting workstations boxes

NU17•418: 2,3 and 4 columns - 8 modules

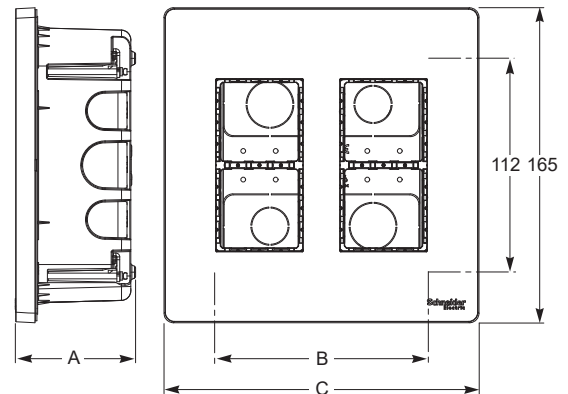

Vertical flush mounting workstations boxes

Type	Depth	2 rows 8 modules		2 rows 10 modules		2 columns 4 modules		3 columns 4 modules		4 columns 4 modules	
		A	B	C	B	C	B	C	B	C	B
Flush mounting workstations boxes	63	177	230	248	300	112	165	177	230	248	300

Surface workstations boxes

NU121•20: 2 rows - 8 or 10 modules

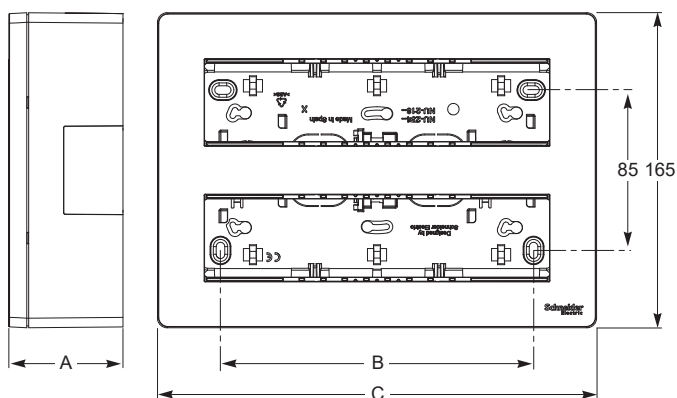

Horizontal surface workstations boxes

NU12•418: 2,3 and 4 columns - 8 modules

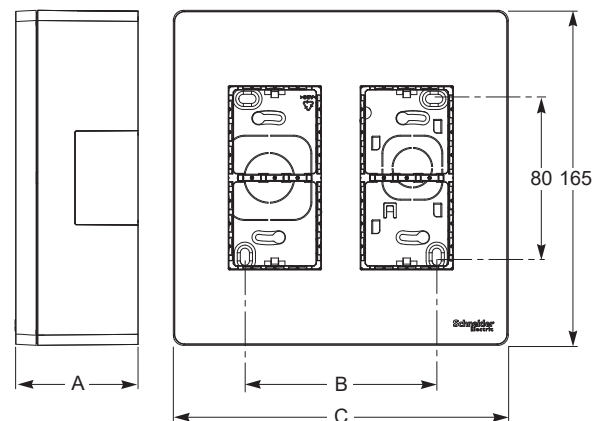

Vertical surface workstations boxes

Type	Depth	2 rows 8 modules		2 rows 10 modules		2 columns 4 modules		3 columns 4 modules		4 columns 4 modules	
		A	B	C	B	C	B	C	B	C	B
Surface workstations boxes	60	160	230	233	300	94.5	165	160	230	233	300

Switches and push-buttons

Connection examples

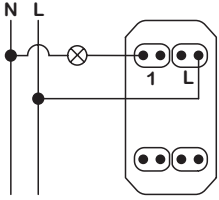

1 module - One-way switch

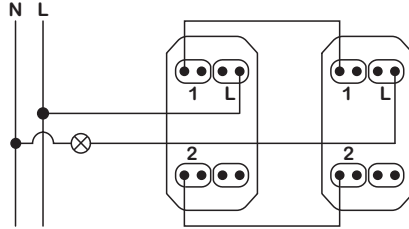

1 module - 2 two-way switches

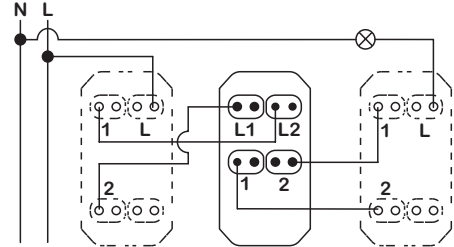

1 module - 2 two-way switches + 1 intermediate switch

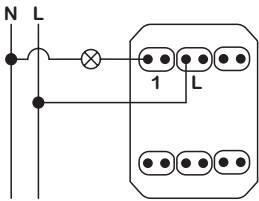

2 modules - One-way switch

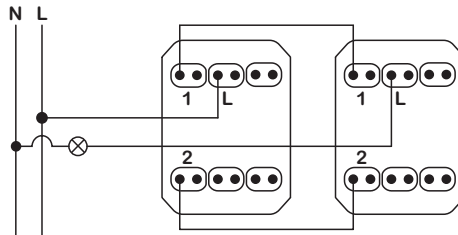

2 modules - Two-way switch

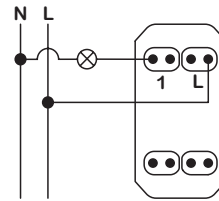

1 module - Push-button

Switches and push-buttons with indication lamp

Connection examples

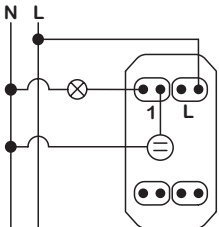

1 module - One-way switch with indication lamp

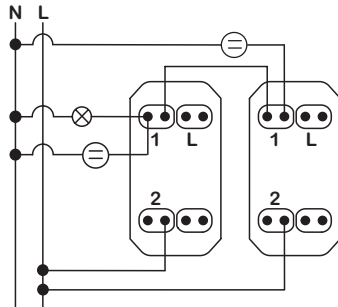

1 module - 2 two-way switches with indication lamp

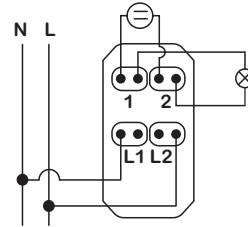

Double pole switch with indication lamp

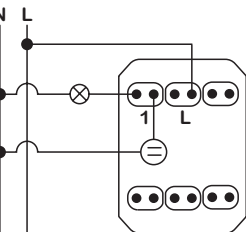

2 modules - One-way switch with indication lamp

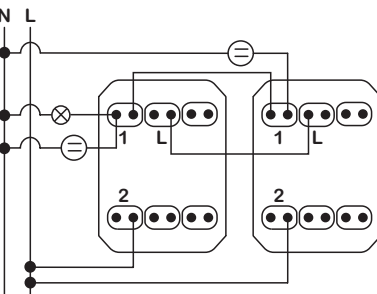

2 modules - 2 two-way switches with indication lamp

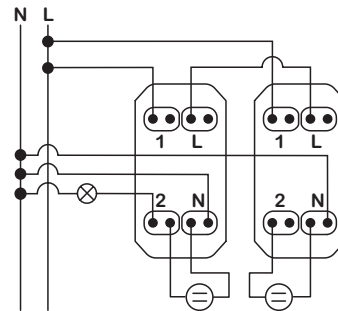

1 module - 2 two-way switches with indication lamp and neutral connection

Unica

Connections

Control inserts

Switches and push-buttons with location lamp

Connection examples

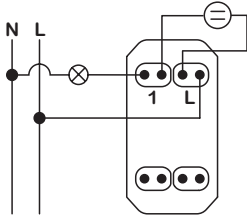

1 module - One-way switch with location lamp

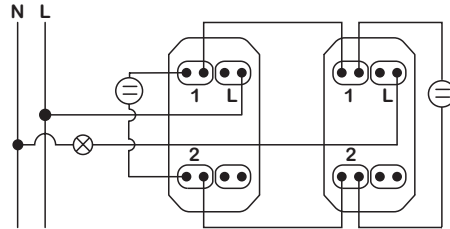

1 module - 2 two-way switches with location lamp

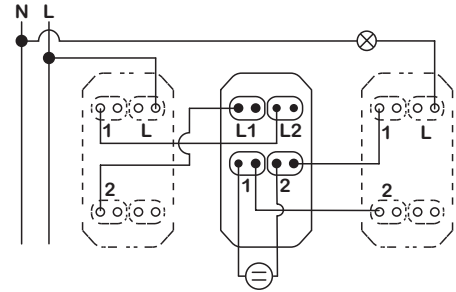

1 module - 2 two-way switches + 1 intermediate with location lamp

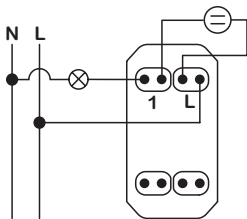

1 module - Push-button with location lamp

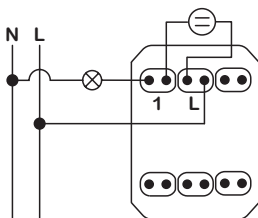

2 modules - One-way switch with location lamp

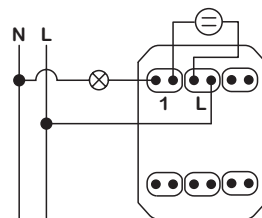

2 modules - Push-button with location lamp

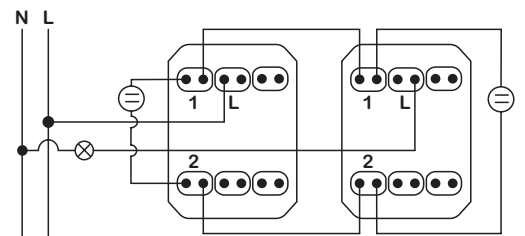

2 modules - Two way switch with location lamp

Room control

Room control unit and lamp & bell push-button

A: NU5217●● & B: NU5777●●

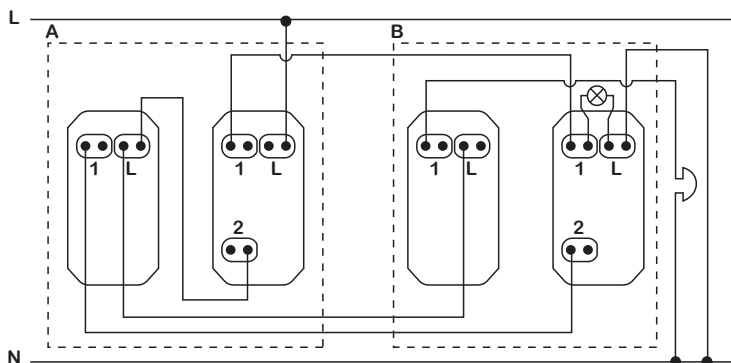

Control unit and lamp & bell push-button connection for room indication

Connections

Comfort control inserts

Universal rotary dimmer LED
NU35141●●

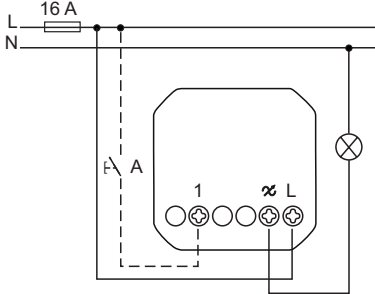

Controlling blinds locally

Motion sensor with switch 10 A
NU3525●●

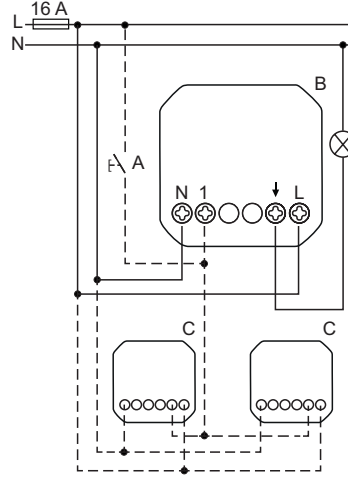

Detection moving heat sources
 (e.g. persons)

Countdown timer 10 A
NU3535●●

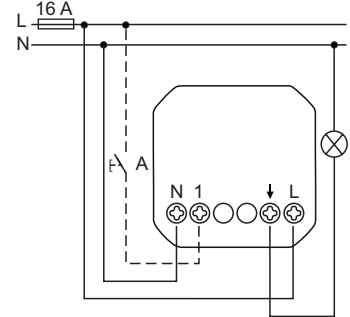

Manual switching off or restarting
 the overtravel time with an activated
 overtravel time

Floor thermostats 10 A
NU3503●●

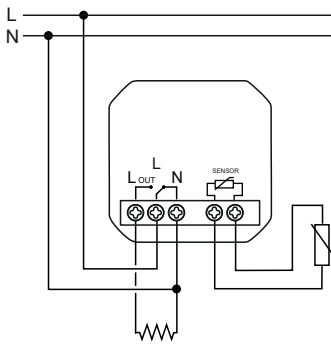

Room thermostats 8 A
NU3501●●

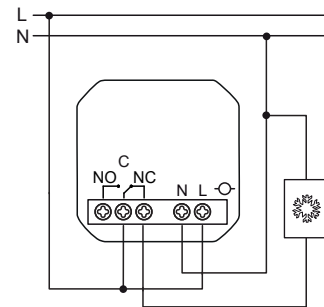
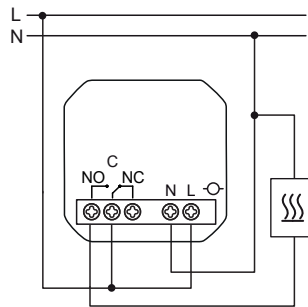

Connections

Comfort Wiser inserts

Wiser blind control switch
NU3508●●

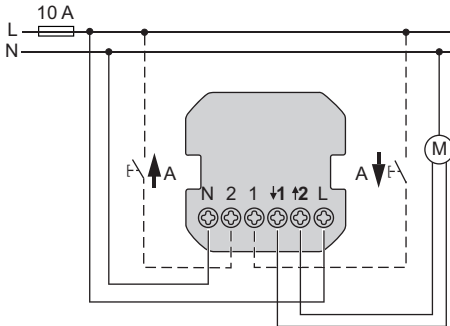

Controlling blinds locally via the Internet using Wiser Home Touch

Wiser motion sensor with switch 10 A
NU3526●●

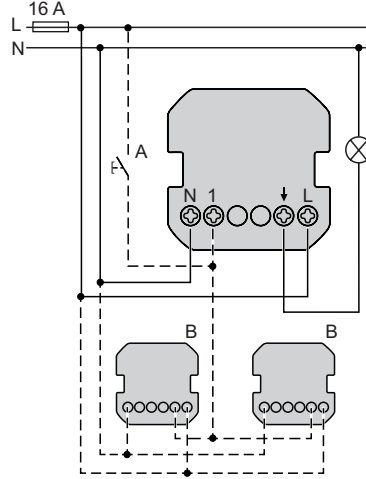

Detection moving heat sources (e.g. persons) via the Internet using Wiser Home Touch

Wiser/Floor thermostat
NU5505●●

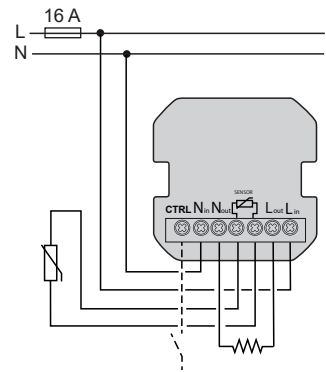

Wiser motion sensor with universal push-button dimmer LED
NU3527●●

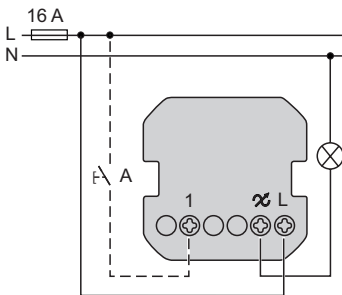

Detection moving heat sources (e.g. persons) and can dim ohmic via the Internet using Wiser Home Touch

Wiser relay switch 10 A
NU3537●●

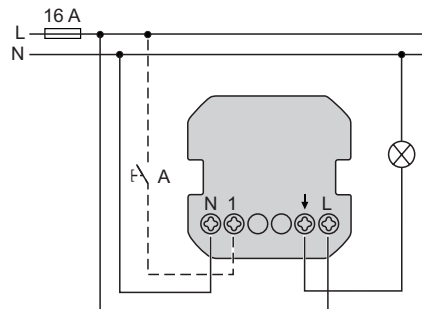

Room control and Home control with Wiser control via the Internet using Wiser Home Touch

Wiser universal push-button dimmer LED
NU3515●●

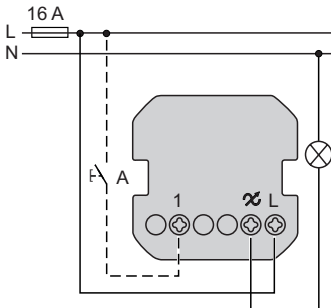

Room control and Home control with Wiser control via the Internet using Wiser Home Touch

Wiser universal rotary dimmer LED
NU3516●●

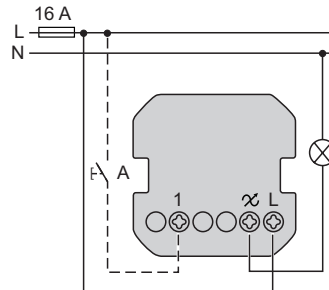

Room control and Home control with Wiser control via the Internet using Wiser Home Touch

Unica

Connections

Specialized control

Electronic door bell NU3535●●

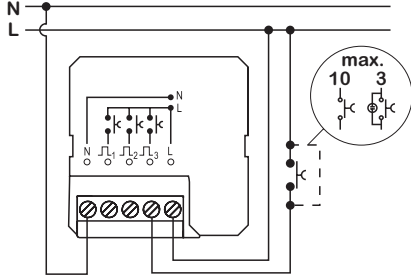

Manual switching off or restarting the overtravel time with an activated overtravel time

USB data connector NU3501●●

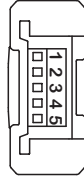

1	Vbus (5V DC)	█
2	D-	—
3	D+	█
4	GND	█
5	⏏	█

Unica

Connections

Socket-outlets

USB Chargers

Type A: **NU3428** (1 module) - **NU3418** (2 modules)

Type A + C : **NU3018** (2 modules)

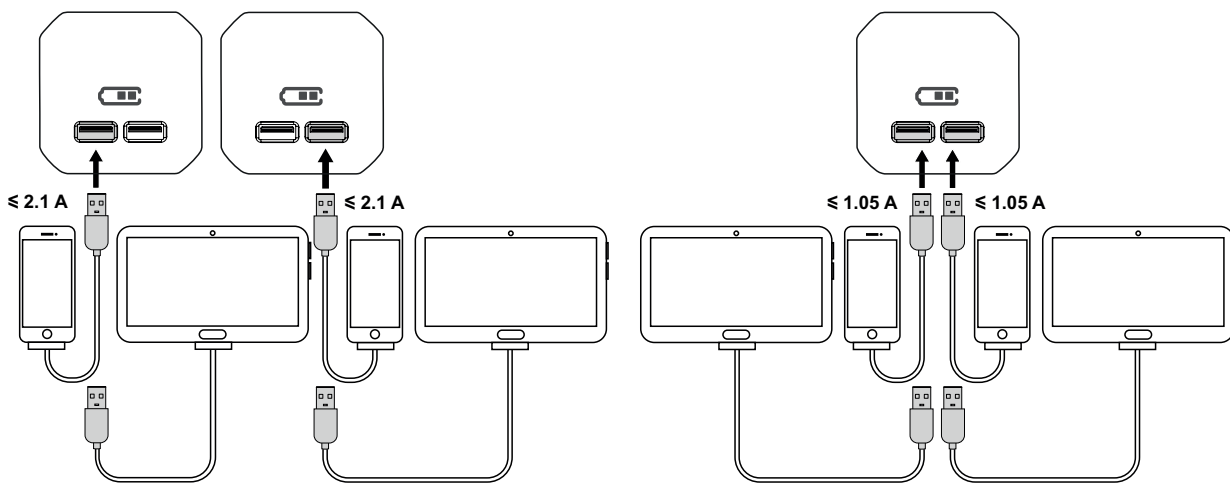
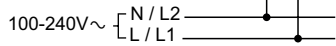
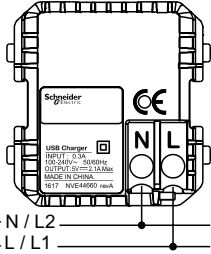

USB type A connection

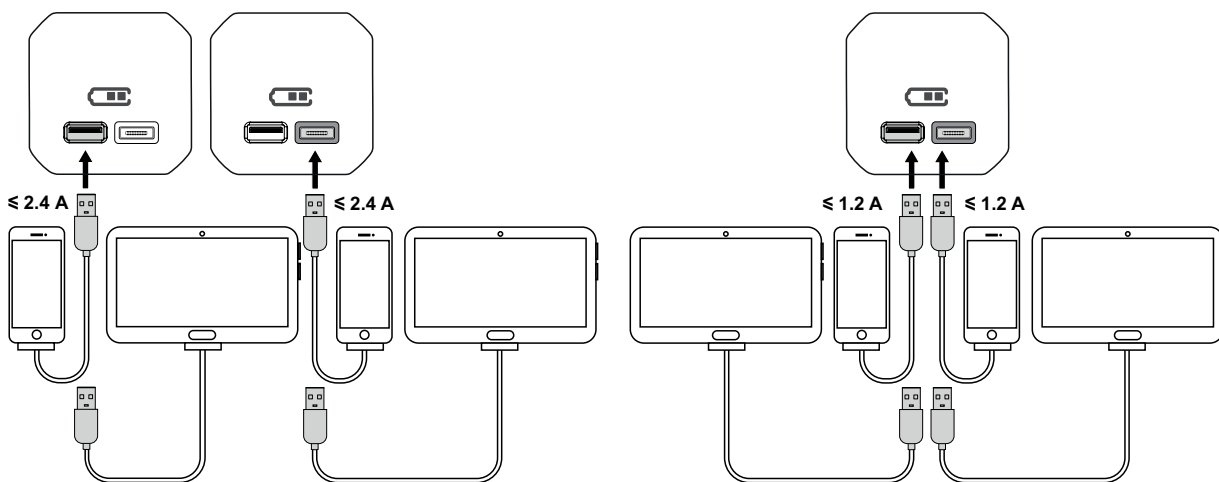

USB type A + C connection

Connections

RJ45 data sockets

Installation

Example of unshielded punch down data socket installation

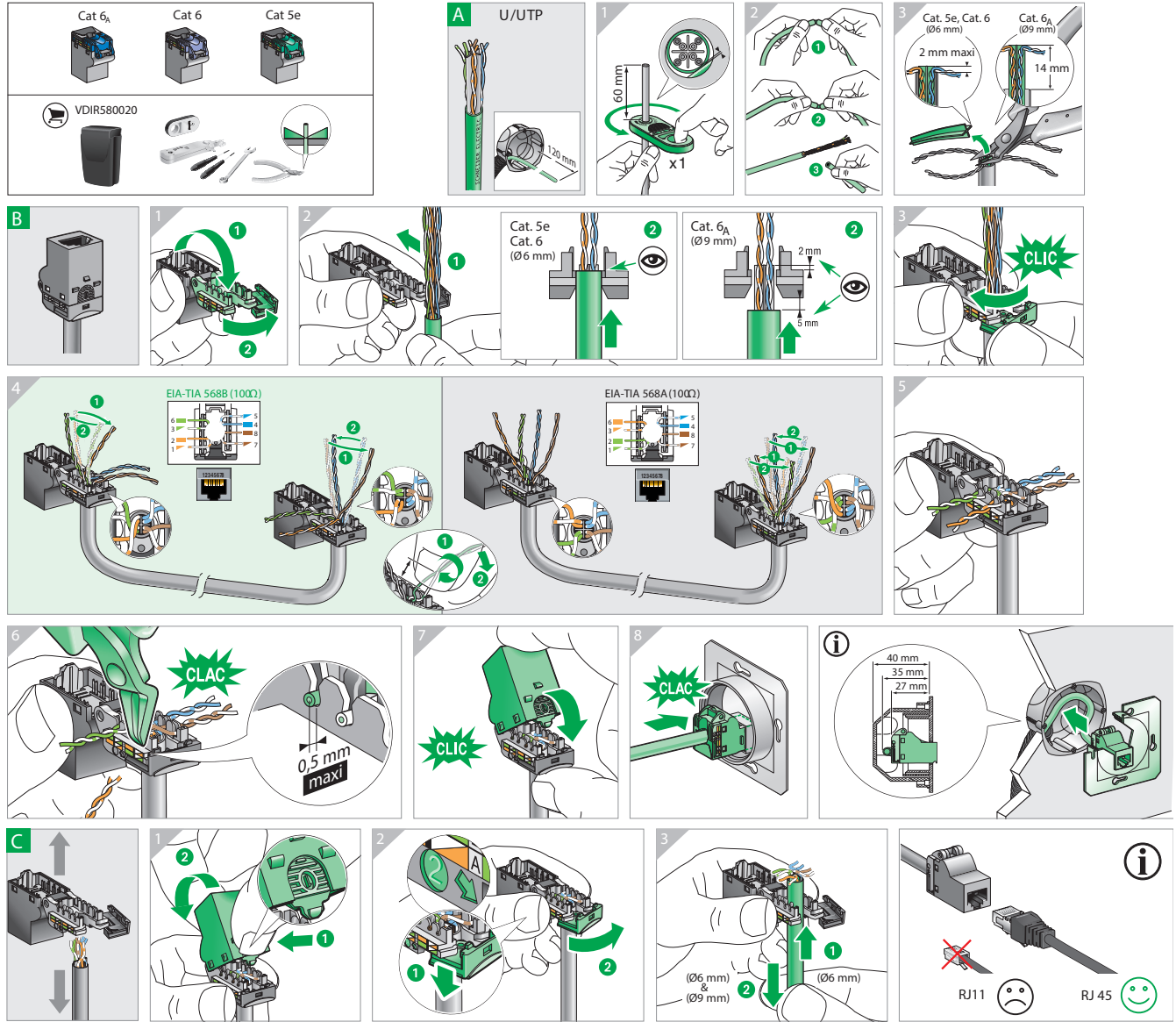

Technical data

Categories

- The most important property defining a data network is the speed at which information can circulate inside this network.
- According to this aspect, installations are classed into the following categories

Category	Transmission rate	Network type
Cat. 3	Up to 10 MHz	Ethernet 10 Base T, Token Ring 4 Mbps
Cat. 4	Up to 16 MHz	Token Ring 16 Mbps
Cat. 5 _E	Up to 100 MHz	Ethernet 1000 Base T, ATM 155 Mbps
Cat. 6	Up to 250 MHz	Ethernet 1000 Base T, ATM 1200
Cat. 6 _A	Up to 500 MHz	Ethernet full-duplex mode 1000 Base T

Connections

RJ45 data sockets

Installation

Example of unshielded punch down data socket installation

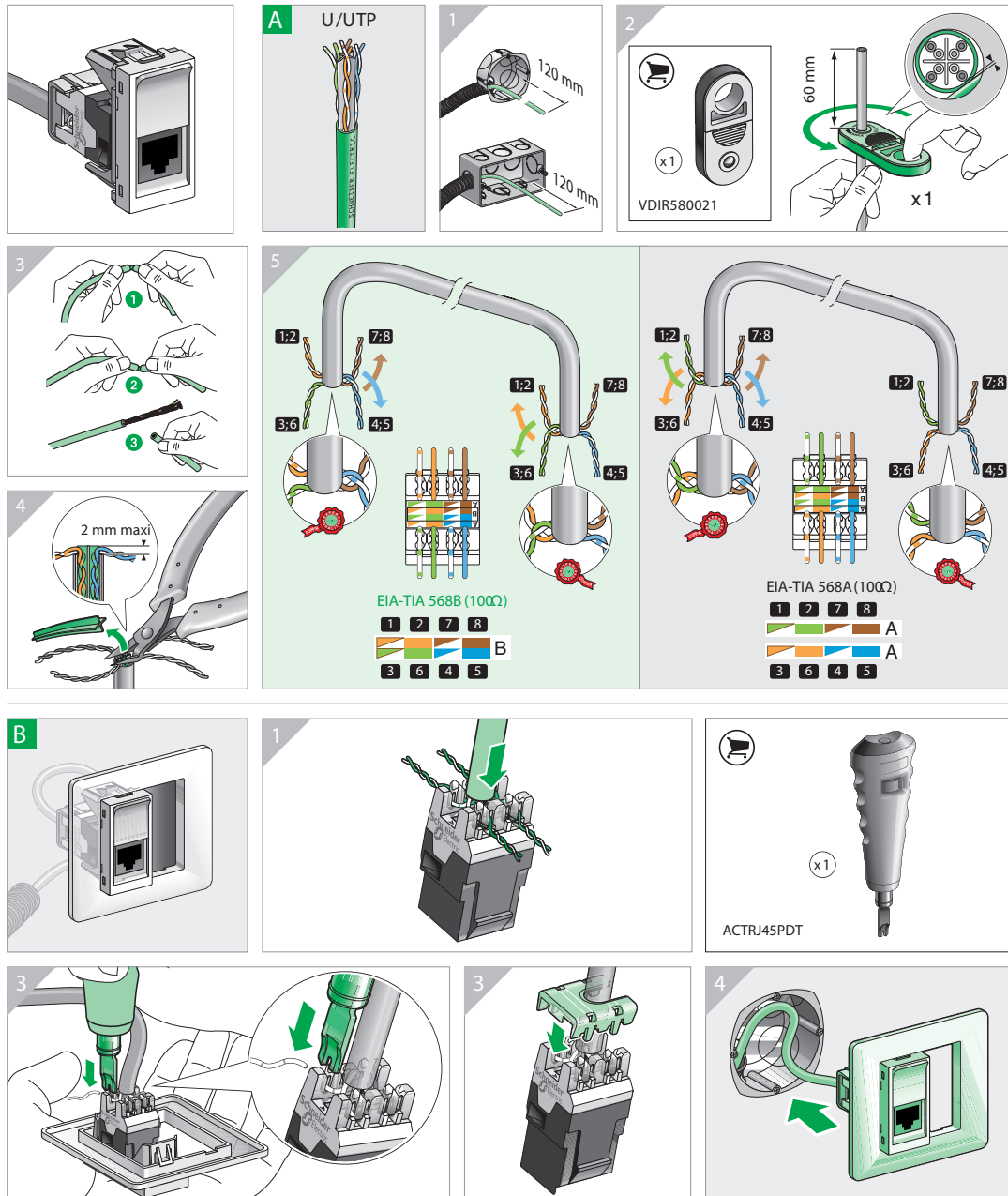

Unica Index

Reference number overview

Ref	Pages	Ref	Pages	Ref	Pages	Ref	Pages	Ref	Pages
ALB45032	48	NU7103	76	NU200218	78	NU280257	79	NU280814	78
ALB45033	48	NU7103P	76	NU200230	78	NU280258	79	NU280815	78
ALB45290	51	NU7104	76	NU200244	78	NU280259	79	NU280816	78
IMT35914	77	NU7204P	84	NU200254	78	NU280260	79	NU280817	78
IMT35914P	77	NU7802	76	NU200418	78	NU280262	79	NU280818	78
IMT35915	77	NU7892	76	NU200430	78	NU280411	78	NU280821	78
IMT35924	77	NU8710	84	NU200444	78	NU280412	78	NU280822	78
IMT35925	77	NU8718	84	NU200454	78	NU280413	78	NU280824	78
IMT35934	77	NU8724	84	NU200618	78	NU280414	78	NU280826	78
IMT35935	77	NU8734	84	NU200630	78	NU280415	78	NU280827	78
IMT35944	77	NU8744	84	NU200644	78	NU280416	78	NU280828	78
IMT35945	77	NU9091	51	NU200654	78	NU280417	78	NU280844	78
IMT35994	77	NU9580	56	NU200818	78	NU280418	78	NU280850	79
IMT35995	77	NU9800	84	NU200830	78	NU280421	78	NU280851	79
MGU5.064.18	64	NU9801	84	NU200844	78	NU280422	78	NU280852	79
MGU5.064.30	64	NU9802	84	NU200854	78	NU280424	78	NU280853	79
MGU8.601	77	NU9823AM	47, 61, 90	NU201018	78	NU280426	78	NU280855	79
MGU8.603	77	NU9825A	47, 61, 90	NU201030	78	NU280427	78	NU280856	79
MGU8.604	77	NU9825AZ	47, 61, 90	NU201044	78	NU280428	78	NU280857	79
MUR34101	56	NU9830	51, 64	NU201054	78	NU280444	78	NU280858	79
MUR34107	56	NU021020	84, 95	NU203718	51, 64	NU280450	79	NU280859	79
MUR34108	56	NU021030	84	NU206318	51, 64	NU280451	79	NU280860	79
MUR34109	56	NU021054	84	NU206344	51, 64	NU280452	79	NU280862	79
MUR34151	56	NU021820	84, 95	NU206718	51, 64	NU280453	79	NU281450	79
MUR35110	56	NU021830	84	NU206730	51, 64	NU280455	79	NU281452	79
MUR37713	56	NU021854	84	NU206744	51, 64	NU280456	79	NU281453	79
MUR37911	56	NU022418	84	NU206754	51, 64	NU280457	79	NU281455	79
MUR37912	56	NU023418	84	NU210118	78	NU280458	79	NU281456	79
MUR37914	56	NU024418	84	NU210130	78	NU280459	79	NU301818	54
MUR39101	56	NU044218	80	NU210154	78	NU280460	79	NU301830	54
MUR39107	56	NU112118	84	NU210218	78	NU280462	79	NU301854	54
MUR39108	56	NU113118	84	NU210230	78	NU280611	78	NU303118	51
MUR39109	56	NU114118	84	NU210254	78	NU280612	78	NU303130	51
MUR39110	56	NU121020	85, 95	NU210318	78	NU280613	78	NU303154	51
MUR39151	56	NU121820	85, 95	NU210330	78	NU280614	78	NU303318	51
MUR39911	56	NU122418	85	NU210354	78	NU280615	78	NU303330	51
MUR39912	56	NU122430	85	NU210418	78	NU280616	78	NU303354	51
MUR39913	56	NU122454	85	NU210430	78	NU280617	78	NU303618	51
MUR39914	56	NU123418	85	NU210454	78	NU280618	78	NU303703	51
NU003718	51	NU123430	85	NU280211	78	NU280621	78	NU303718	51
NU003744	51	NU123454	85	NU280212	78	NU280622	78	NU303718TA	51
NU3772	55	NU124418	85	NU280213	78	NU280624	78	NU303730	51
NU3773	55	NU124430	85	NU280214	78	NU280626	78	NU303730TA	51
NU3774	55	NU124454	85	NU280215	78	NU280627	78	NU303754	51
NU3775	55	NU171020	85, 95	NU280216	78	NU280628	78	NU303754TA	51
NU3776	55	NU171820	85, 95	NU280217	78	NU280644	78	NU303903E	50
NU6004V80	80	NU172418	85	NU280218	78	NU280650	79	NU303918	50
NU6004V82	80	NU172430	85	NU280221	78	NU280651	79	NU303918E	50
NU6004V83	80	NU172454	85	NU280222	78	NU280652	79	NU303930	50
NU6004V84	80	NU173418	85	NU280224	78	NU280653	79	NU303954	50
NU6004V85	80	NU173430	85	NU280226	78	NU280655	79	NU304903	50, 92
NU6004V86	80	NU173454	85	NU280227	78	NU280656	79	NU304903T	50, 92
NU6004V87	80	NU174418	85	NU280228	78	NU280657	79	NU304906	50, 92
NU6004V89	80	NU174430	85	NU280244	78	NU280658	79	NU304918	50
NU7002	76	NU174454	85	NU280250	79	NU280659	79	NU304918T	50
NU7002P	76	NU200118	80	NU280251	79	NU280660	79	NU304920	92
NU7002PC	76	NU200130	80	NU280252	79	NU280662	79	NU304930	50
NU7004PC	76	NU200154	80	NU280253	79	NU280811	78	NU304954	50
NU7006C	76			NU280255	79	NU280812	78	NU305103	50, 92
NU7008C	76			NU280256	79	NU280813	78	NU305103T	50, 92

Reference number overview

Ref	Pages	Ref	Pages	Ref	Pages	Ref	Pages	Ref	Pages
NU305118	50	NU307930	50	NU320618FN	47	NU340630	52	NU344818	52
NU305203	50, 92	NU307954	50	NU320618L	47	NU340654	52	NU344830	52
NU305203T	50, 92	NU310118	46	NU320618LN	47	NU340718	52	NU344854	52
NU305206	50, 92	NU310130	46	NU320618N	47	NU340730	52	NU344918	52
NU305218	50	NU310154	46	NU320620	90	NU340754	52	NU344930	52
NU305218T	50	NU310318	46	NU320620N	90	NU341018	52	NU344954	52
NU305220	92	NU310318F	46	NU320630	47	NU341030	52	NU345018	54
NU305230	50	NU310318S	46	NU320630C	47	NU341054	52	NU345020	93
NU305254	50	NU310320	90	NU320630CN	47	NU341118	52	NU345030	54
NU305703	51	NU310330	46	NU320630L	47	NU341130	52	NU345054	54
NU305706	51	NU310330S	46	NU320630LN	47	NU341154	52	NU345118	54
NU305718	51	NU310354	46	NU320630N	47	NU341218	52	NU345130	54
NU305730	51	NU310354S	46	NU320654	47	NU341230	52	NU345154	54
NU305754	51	NU310518	46	NU320654C	47	NU341318	52	NU345218	54
NU305903	50, 92	NU310530	46	NU320654CN	47	NU341330	52	NU345230	54
NU305903T	50, 92	NU310554	46	NU320654L	47	NU341418	52	NU345254	54
NU305906	50, 92	NU310618	47	NU320654LN	47	NU341430	52	NU345318	54
NU305918	50	NU310618C	47	NU320654N	47	NU341454	52	NU345330	54
NU305920	92	NU310618F	47	NU320718	48	NU341518	52	NU345354	54
NU305920T	50	NU310618L	47	NU320730	48	NU341530	52	NU345418	54
NU305930	50	NU310618N	47	NU320754	48	NU341554	52	NU345430	54
NU305954	50	NU310620	90	NU320818	48	NU341618	52	NU345454	54
NU305961	50	NU310630	47	NU320820	91	NU341630	52	NU345518	54
NU306103	50, 92	NU310630C	47	NU320830	48	NU341654	52	NU345530	54
NU306103S	50, 92	NU310630L	47	NU320854	48	NU341718	52	NU345554	54
NU306103T	50, 92	NU310630N	47	NU321118	46	NU341730	52	NU345618	54
NU306703	51	NU310654	47	NU321318	46	NU341754	52	NU345630	54
NU306703A	51	NU310654C	47	NU321318F	46	NU341818	54	NU345654	54
NU306703AS	51	NU310654L	47	NU321330	46	NU341830	54	NU346118	54
NU306703S	51	NU310654N	47	NU321354	46	NU341854	54	NU346120	93
NU306706AS	51	NU313618	47	NU321418	48	NU341918	52	NU346130	54
NU306718	51	NU313630	47	NU321430	48	NU341930	52	NU346154	54
NU306718A	51	NU313654	47	NU321454	48	NU341954	52	NU346218	54
NU306718AS	51	NU316118	46	NU322518	46	NU342018	52	NU346220	93
NU306718S	51	NU316218	46	NU322620	48, 91	NU342030	52	NU346230	54
NU306730A	51	NU316218S	46	NU322630	48	NU342054	52	NU346254	54
NU306730AS	51	NU316318	46	NU322654	48	NU342618	52	NU346818	54
NU306754A	51	NU316330	46	NU323618	47	NU342630	52	NU346830	54
NU306754AS	51	NU316354	46	NU323630	47	NU342654	52	NU346854	54
NU306761AS	51	NU320118	46	NU323654	47	NU342818	54	NU347818	52
NU306903	50, 92	NU320130	46	NU323718	48	NU342830	54	NU347918	52
NU306903S	50, 92	NU320154	46	NU323730	48	NU342854	54	NU348218	52
NU306903SE	50	NU320318	46	NU323754	48	NU342918	54	NU348318	52
NU306903T	50, 92	NU320318F	46	NU324620	47, 90	NU342930	54	NU348418	52
NU306906	50, 92	NU320318S	46	NU324630	47	NU342954	54	NU348518	52
NU306918	50	NU320320	90	NU324654	47	NU343018	54	NU348618	54
NU306918S	50	NU320320VMC	48, 91	NU326118	46	NU343030	54	NU348630	54
NU306918SE	50	NU320330	46	NU326218	46	NU343054	54	NU348654	54
NU306918T	50	NU320330S	46	NU326218S	46	NU343118	54	NU348718	54
NU306930	50	NU320330VMC	48	NU326230	46	NU343130	54	NU348730	54
NU306930S	50	NU320354	46	NU326230S	46	NU343154	54	NU348754	54
NU306954	50	NU320354S	46	NU326254	46	NU343218	54	NU349118	53
NU306954S	50	NU320354VMC	48	NU326254S	46	NU343230	54	NU349130	53
NU307103	50, 92	NU320518	46	NU326318	46	NU343254	54	NU349154	53
NU307103T	50, 92	NU320530	46	NU326330	46	NU343318	54	NU349618	53
NU307903	50, 92	NU320554	46	NU326354	46	NU343330	54	NU349630	53
NU307903T	50, 92	NU320618	47	NU328318	48	NU343354	54	NU349654	53
NU307906	50, 92	NU320618C	47	NU328330	48	NU344718	52	NU349718	53
NU307918	50	NU320618CN	47	NU328354	48	NU344730	52	NU349730	53
NU307918T	50	NU320618F	47	NU340618	52	NU344754	52	NU349754	53

Reference number overview

Ref	Pages	Ref	Pages	Ref	Pages	Ref	Pages	Ref	Pages
NU350118	49	NU400418	80	NU520118	60	NU521718	62	NU545644	66
NU350130	49	NU400420	95	NU520118N	60	NU521730	62	NU545654	66
NU350154	49	NU400430	80	NU520130	60	NU521744	62	NU545718	54
NU350318	49	NU400454	80	NU520130N	60	NU521754	62	NU545730	54
NU350330	49	NU400618	80	NU520144	60	NU522618	62	NU545754	54
NU350354	49	NU400630	80	NU520144N	60	NU522644	62	NU546118	65
NU350818	72	NU400654	80	NU520154	60	NU526218	60	NU546130	65
NU350820	73, 94	NU400818	80	NU520154N	60	NU526218S	60	NU546144	65
NU350830	72	NU400830	80	NU520318	60	NU526230	60	NU546154	65
NU350854	72	NU400854	80	NU520318N	60	NU526230S	60	NU546218	66
NU351418	49	NU406918	50	NU520330	60	NU526244	60	NU546230	66
NU351420	91	NU406930	50	NU520330N	60	NU526244S	60	NU546244	66
NU351430	49	NU406954	50	NU520344	60	NU526254	60	NU546254	66
NU351454	49	NU411018	80	NU520344N	60	NU526254S	60	NU546318	66
NU351518	72	NU411030	80	NU520354	60	NU528318	62	NU546330	66
NU351520	73, 94	NU411054	80	NU520354N	60	NU528330	62	NU546344	66
NU351530	72	NU411418	80	NU520518	60	NU528344	62	NU546354	66
NU351554	72	NU411420	95	NU520518N	60	NU528354	62	NU546418	66
NU351618	72	NU411430	80	NU520530	60	NU541118	65	NU546430	66
NU351620	73, 94	NU411454	80	NU520530N	60	NU541130	65	NU546444	66
NU351630	72	NU411618	80	NU520544	60	NU541144	65	NU546454	66
NU351654	72	NU411620	95	NU520544N	60	NU541154	65	NU547018	66
NU352518	49	NU411630	80	NU520554	60	NU541518	65	NU547030	66
NU352530	49	NU411654	80	NU520554N	60	NU541530	65	NU547054	66
NU352554	49	NU411818	80	NU520618	61	NU541544	65	NU548618	66
NU352618	72	NU411830	80	NU520618N	61	NU541554	65	NU548630	66
NU352620	73, 94	NU411854	80	NU520630	61	NU541818	65	NU548644	66
NU352630	72	NU501818	65	NU520630N	61	NU541830	65	NU548654	66
NU352654	72	NU501830	65	NU520644	61	NU541844	65	NU548918	66
NU352718	72	NU501844	65	NU520644N	61	NU541854	65	NU548930	66
NU352720	73, 94	NU501854	65	NU520654	61	NU542018	65	NU548944	66
NU352730	72	NU503118	64	NU520654N	61	NU542030	65	NU548954	66
NU352754	72	NU503130	64	NU520718	62	NU542044	65	NU549218	65
NU353518	49	NU503144	64	NU520730	62	NU542054	65	NU549230	65
NU353530	49	NU503154	64	NU520744	62	NU542418	65	NU549244	65
NU353554	49	NU503318	64	NU520754	62	NU542430	65	NU549254	65
NU353718	72	NU503330	64	NU520818	62	NU542444	65	NU550118	63
NU353720	73, 94	NU503344	64	NU520830	62	NU542454	65	NU550130	63
NU353730	72	NU503354	64	NU520844	62	NU542718	65	NU550144	63
NU353754	72	NU503618	64	NU520854	62	NU542730	65	NU550154	63
NU363118	56	NU503630	64	NU521118	60	NU542744	65	NU550318	63
NU363130	56	NU503644	64	NU521118N	60	NU542754	65	NU550330	63
NU363154	56	NU503654	64	NU521130	60	NU543018	65	NU550344	63
NU370118	48	NU503703	64	NU521130N	60	NU543030	65	NU550354	63
NU373118	48	NU503718	64	NU521144	60	NU543044	65	NU550518	71
NU373130	48	NU503718TA	64	NU521144N	60	NU543054	65	NU550530	71
NU373154	48	NU503730	64	NU521154	60	NU543118	65	NU550544	71
NU378518	55	NU503730TA	64	NU521154N	60	NU543130	65	NU550554	71
NU378530	55	NU503744	64	NU521318	60	NU543144	65	NU550818	70
NU378554	55	NU503744TA	64	NU521318N	60	NU543154	65	NU550830	70
NU378618	55	NU503754	64	NU521330	60	NU545418	66	NU550844	70
NU378630	55	NU503754TA	64	NU521330N	60	NU545430	66	NU550854	70
NU378654	55	NU505618	64	NU521344	60	NU545444	66	NU551418	63
NU386218	56	NU505630	64	NU521344N	60	NU545454	66	NU551430	63
NU386230	56	NU505644	64	NU521354	60	NU545518	66	NU551444	63
NU386254	56	NU505654	64	NU521354N	60	NU545530	66	NU551454	63
NU400218	80	NU505718	64	NU521518	60	NU545544	66	NU551518	70
NU400220	95	NU505730	64	NU521530	60	NU545554	66	NU551530	70
NU400230	80	NU505744	64	NU521544	60	NU545618	66	NU551544	70
NU400254	80	NU505754	64	NU521554	60	NU545630	66	NU551554	70

Reference number overview

Ref	Pages	Ref	Pages	Ref	Pages	Ref	Pages
NU551618	70	NU600480	80	NU920018	47, 61	NU946430	53
NU551630	70	NU600482	80	NU920018N	47, 61	NU946454	53
NU551644	70	NU600483	80	NU920018U	47, 61	NU947818	53
NU551654	70	NU600484	80	NU920020	90	NU947830	53
NU552518	63	NU600485	80	NU920020N	90	NU947854	53
NU552530	63	NU600486	80	NU920030	47, 61	NU947918	53
NU552544	63	NU600487	80	NU920030N	47, 61	NU947930	53
NU552554	63	NU600489	80	NU920030U	47, 61	NU947954	53
NU552618	71	NU600680	80	NU920054	47, 61	NU986418	56
NU552630	71	NU600682	80	NU920054N	47, 61	NU986430	56
NU552644	71	NU600683	80	NU920054U	47, 61	NU986454	56
NU552654	71	NU600684	80	NU940618	53	NU986518	56
NU552718	71	NU600685	80	NU940620	93	NU986520	93
NU552730	71	NU600686	80	NU940630	53	NU986530	56
NU552744	71	NU600687	80	NU940654	53	NU986554	56
NU552754	71	NU600689	80	NU940718	53	NU986618	56
NU553018	87	NU600880	80	NU940720	93	NU986620	93
NU553020	87	NU600882	80	NU940730	53	NU986630	56
NU553030	87	NU600883	80	NU940754	53	NU986654	56
NU553054	87	NU600884	80	NU941018	53	S520299	47, 61, 90
NU553118	87	NU600885	80	NU941020	93	U0.582	76
NU553120	87	NU600886	80	NU941030	53	U22.805	84
NU553130	87	NU600887	80	NU941044	53		
NU553154	87	NU600889	80	NU941054	53		
NU553518	63	NU800218	77	NU941118	53		
NU553530	63	NU800244	77	NU941118T	53		
NU553544	63	NU800418	77	NU941120	93		
NU553554	63	NU800444	77	NU941130	53		
NU553718	70	NU800618	77	NU941144	53		
NU553730	70	NU800644	77	NU941154	53		
NU553744	70	NU821020	84, 95	NU942018	53		
NU553754	70	NU821030	84	NU942020	93		
NU577718	62	NU821054	84	NU942030	53		
NU577730	62	NU821820	84, 95	NU942054	53		
NU577744	62	NU821830	84	NU943818	53		
NU577754	62	NU821854	84	NU943830	53		
NU578618	62	NU822418	84	NU943854	53		
NU578630	62	NU823418	84	NU943918	53		
NU578644	62	NU824418	84	NU943930	53		
NU578654	62	NU840218	77	NU943954	53		
NU586218	67	NU840418	77	NU944018	54, 66		
NU586230	67	NU840618	77	NU944030	54, 66		
NU586244	67	NU903718	51	NU944044	54, 66		
NU586254	67	NU903718U	51	NU944054	54, 66		
NU586618	67	NU903720	92	NU944118	54, 66		
NU586630	67	NU903730	51	NU944130	54, 66		
NU586644	67	NU903730U	51	NU944154	54, 66		
NU586654	67	NU903754	51	NU946018	53		
NU593218	65	NU903754U	51	NU946030	53		
NU593230	65	NU910018	47, 61	NU946054	53		
NU593244	65	NU910018N	47, 61	NU946118	53		
NU593254	65	NU910018U	47, 61	NU946130	53		
NU600280	80	NU910020	90	NU946154	53		
NU600282	80	NU910020N	90	NU946218	53		
NU600283	80	NU910030	47, 61	NU946230	53		
NU600284	80	NU910030N	47, 61	NU946254	53		
NU600285	80	NU910030U	47, 61	NU946318	53		
NU600286	80	NU910054	47, 61	NU946330	53		
NU600287	80	NU910054N	47, 61	NU946354	53		
NU600289	80	NU910054U	47, 61	NU946418	53		



Green Premium™

Endorsing eco-friendly products in the industry



Green Premium™

Product

Green Premium is the only label that allows you to effectively develop and promote an environmental policy whilst preserving your business efficiency. This ecolabel guarantees compliance with up-to-date environmental regulations, but it does more than this.

Over 75% of Schneider Electric manufactured products have been awarded the Green Premium ecolabel



Discover what we mean by green ...

Check your products!

Schneider Electric's Green Premium ecolabel is committed to offering transparency, by disclosing extensive and reliable information related to the environmental impact of its products:

RoHS

Schneider Electric products are subject to RoHS requirements at a worldwide level, even for the many products that are not required to comply with the terms of the regulation. Compliance certificates are available for products that fulfil the criteria of this European initiative, which aims to eliminate hazardous substances.

REACH

Schneider Electric applies the strict REACH regulation on its products at a worldwide level, and discloses extensive information concerning the presence of SVHC (Substances of Very High Concern) in all of its products.

PEP: Product Environmental Profile

Schneider Electric publishes complete set of environmental data, including carbon footprint and energy consumption data for each of the lifecycle phases on all of its products, in compliance with the ISO 14025 PEP ecopassport program. PEP is especially useful for monitoring, controlling, saving energy, and/or reducing carbon emissions.

EoLI: End of Life Instructions

Available at the click of a button, these instructions provide:

- Recyclability rates for Schneider Electric products.
- Guidance to mitigate personnel hazards during the dismantling of products and before recycling operations.
- Parts identification for recycling or for selective treatment, to mitigate environmental hazards/ incompatibility with standard recycling processes.

Life Is On



Schneider Electric Industries SAS

35, rue Joseph Monier
CS 30323
92506 Rueil Malmaison Cedex
France

RCS Nanterre 954 503 439
Capital social 896 313 776 €
www.schneider-electric.com

01-2019

© 2019 - Schneider Electric. All Rights Reserved.
All trademarks are owned by Schneider Electric Industries SAS or its affiliated companies.
Document reference: LSB03605EN

This document has been
printed on recycled paper

